

NCP662, NCV662, NCP663, NCV663

100 mA CMOS Low Iq Low-Dropout Voltage Regulator

This series of fixed output low-dropout linear regulators are designed for handheld communication equipment and portable battery powered applications which require low quiescent current. This series features an ultra-low quiescent current of 2.5 μ A. Each device contains a voltage reference unit, an error amplifier, a PMOS power transistor, resistors for setting output voltage, current limit, and temperature limit protection circuits. The NCP662/NCV662 series provides an enable pin for ON/OFF control.

This series has been designed to be used with low cost ceramic capacitors and requires a minimum output capacitor of 0.1 μ F. The device is housed in the micro-miniature SC82-AB surface mount package. Standard voltage versions are 1.5, 1.8, 2.5, 2.7, 2.8, 3.0, 3.3, and 5.0 V.

Features

- Low Quiescent Current of 2.5 μ A Typical
- Low Output Voltage Option
- Output Voltage Accuracy of 2.0%
- Temperature Range for NCV662/NCV663 -40°C to 125°C
Temperature Range for NCP662/NCP663 -40°C to 85°C
- NCP662/NCV662 Provides as Enable Pin
- NCV Prefix for Automotive and Other Applications Requiring Site and Control Changes
- Pb-Free Packages are Available

Typical Applications

- Battery Powered Instruments
- Hand-Held Instruments
- Camcorders and Cameras
- Automotive Infotainment



ON Semiconductor®

<http://onsemi.com>

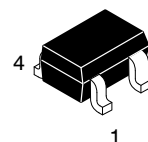

SC82-AB (SC70-4)
SQ SUFFIX
CASE 419C

PIN CONNECTIONS & MARKING DIAGRAMS

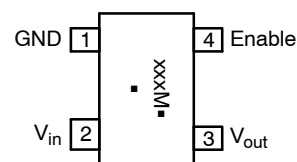

(NCP662/NCV662 Top View)

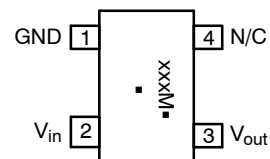

(NCP663/NCV663 Top View)

xxx = Specific Device Code
M = Month Code*
▪ = Pb-Free Package

(Note: Microdot may be in either location)

*Date Code orientation and/or position and underbar may vary depending upon manufacturing location.

ORDERING INFORMATION

See detailed ordering and shipping information in the package dimensions section on page 8 of this data sheet.

*For additional information on our Pb-Free strategy and soldering details, please download the ON Semiconductor Soldering and Mounting Techniques Reference Manual, SOLDERRM/D.

NCP662, NCV662, NCP663, NCV663

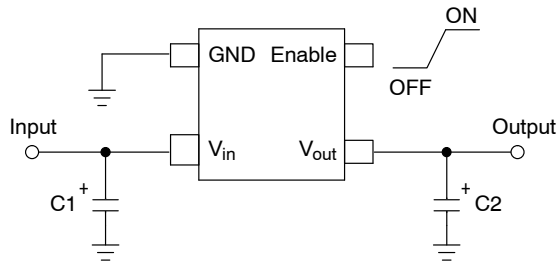

This device contains 28 active transistors

Figure 1. NCP662/NCV662 Typical Application Diagram

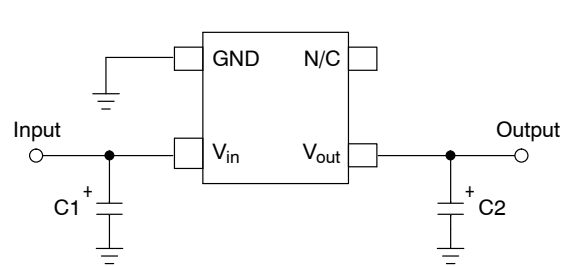

This device contains 28 active transistors

Figure 2. NCP663/NCV663 Typical Application Diagram

PIN FUNCTION DESCRIPTION

NCP662/ NCV662	NCP663/ NCV663	Pin Name	Description
1	1	GND	Power supply ground.
2	2	V _{in}	Positive power supply input voltage.
3	3	V _{out}	Regulated output voltage.
4	–	Enable	This input is used to place the device into low-power standby. When this input is pulled low, the device is disabled. If this function is not used, Enable should be connected to V _{in} .
–	4	N/C	No internal connection.

MAXIMUM RATINGS

Rating	Symbol	Value	Unit
Input Voltage	V _{in}	6.0	V
Enable Voltage (NCP662/NCV662 ONLY)	Enable	–0.3 to V _{in} +0.3	V
Output Voltage	V _{out}	–0.3 to V _{in} +0.3	V
Power Dissipation and Thermal Characteristics Power Dissipation Thermal Resistance, Junction to Ambient	P _D R _{θJA}	Internally Limited 330	W °C/W
Operating Junction Temperature	T _J	+150	°C
Operating Ambient Temperature NCP662/NCP663 NCV662/NCV663	T _A	–40 to +85 –40 to +125	°C
Storage Temperature	T _{stg}	–55 to +150	°C

Stresses exceeding Maximum Ratings may damage the device. Maximum Ratings are stress ratings only. Functional operation above the Recommended Operating Conditions is not implied. Extended exposure to stresses above the Recommended Operating Conditions may affect device reliability.

- This device series contains ESD protection and exceeds the following tests:
Human Body Model 2000 V per MIL–STD–883, Method 3015
Machine Model Method 200 V
- Latch up capability (85°C) ±100 mA DC with trigger voltage.

NCP662, NCV662, NCP663, NCV663

ELECTRICAL CHARACTERISTICS

($V_{in} = V_{out(nom.)} + 1.0\text{ V}$, $V_{enable} = V_{in}$, $C_{in} = 1.0\ \mu\text{F}$, $C_{out} = 1.0\ \mu\text{F}$, $T_J = 25^\circ\text{C}$, unless otherwise noted.)

Characteristic	Symbol	Min	Typ	Max	Unit
Output Voltage ($I_{out} = 1.0\text{ mA}$) NCP662/NCP663: $T_A = -40^\circ\text{C}$ to 85°C NCV662/NCV663: $T_A = -40^\circ\text{C}$ to 125°C	V_{out}				V
1.5 V		1.463	1.5	1.538	
1.8 V		1.755	1.8	1.845	
2.5 V		2.438	2.5	2.563	
2.7 V		2.646	2.7	2.754	
2.8 V		2.744	2.8	2.856	
3.0 V		2.940	3.0	3.060	
3.3 V		3.234	3.3	3.366	
5.0 V		4.9	5.0	5.1	
Output Voltage ($T_A = -40^\circ\text{C}$ to 85°C , $I_{out} = 100\text{ mA}$)	V_{out}				V
1.5 V		1.433	1.5	1.568	
1.8 V		1.719	1.8	1.881	
2.5 V		2.388	2.5	2.613	
2.7 V		2.592	2.7	2.808	
2.8 V		2.688	2.8	2.912	
3.0 V		2.880	3.0	3.120	
3.3 V		3.168	3.3	3.432	
5.0 V		4.8	5.0	5.2	
Line Regulation 1.5 V–4.4 V ($V_{in} = V_{o(nom.)} + 1.0\text{ V}$ to 6.0 V) 4.5 V–5.0 V ($V_{in} = 5.5\text{ V}$ to 6.0 V)	Reg_{line}	–	10	20	mV
		–	10	20	
Load Regulation ($I_{out} = 10\text{ mA}$ to 100 mA)	Reg_{load}	–	20	40	mV
Output Current ($V_{out} = (V_{out}\text{ at } I_{out} = 100\text{ mA}) - 3.0\%$) 1.5 V to 3.9 V ($V_{in} = V_{out(nom.)} + 2.0\text{ V}$) 4.0 V–5.0 V ($V_{in} = 6.0\text{ V}$)	$I_{o(nom.)}$	100	280	–	mA
		100	280	–	
Dropout Voltage ($I_{out} = 100\text{ mA}$, Measured at $V_{out} - 3.0\%$) NCP662/NCP663: $T_A = -40^\circ\text{C}$ to 85°C NCV662/NCV663: $T_A = -40^\circ\text{C}$ to 125°C	$V_{in} - V_{out}$				mV
1.5 V–1.7 V		–	680	950	
1.8 V–2.4 V		–	500	700	
2.5 V–2.6 V		–	300	500	
2.7 V–2.9 V		–	280	500	
3.0 V–3.2 V		–	250	420	
3.3 V–4.9 V		–	230	420	
5.0 V		–	170	300	
Quiescent Current (Enable Input = 0 V) (Enable Input = V_{in} , $I_{out} = 1.0\text{ mA}$ to $I_{o(nom.)}$)	I_Q	–	0.1	1.0	μA
		–	2.5	6.0	
Output Short Circuit Current 1.5 V to 3.9 V ($V_{in} = V_{nom} + 2.0\text{ V}$) 4.0 V–5.0 V ($V_{in} = 6.0\text{ V}$)	$I_{out(max)}$	150	300	600	mA
		150	300	600	
Output Voltage Noise ($f = 100\text{ Hz}$ to 100 kHz , $V_{out} = 3.0\text{ V}$)	V_n	–	100	–	μVrms
Enable Input Threshold Voltage (NCP662/NCV662 ONLY) (Voltage Increasing, Output Turns On, Logic High) (Voltage Decreasing, Output Turns Off, Logic Low)	$V_{th(en)}$	1.3	–	–	V
		–	–	0.5	
Output Voltage Temperature Coefficient	T_C	–	± 100	–	ppm/ $^\circ\text{C}$

3. Maximum package power dissipation limits must be observed.

$$PD = \frac{T_{J(max)} - T_A}{R_{\theta JA}}$$

4. Low duty cycle pulse techniques are used during testing to maintain the junction temperature as close to ambient as possible.

NCP662, NCV662, NCP663, NCV663

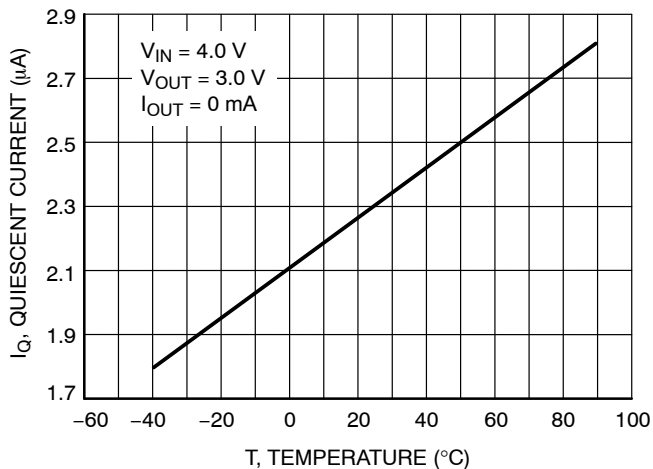

Figure 3. Quiescent Current versus Temperature

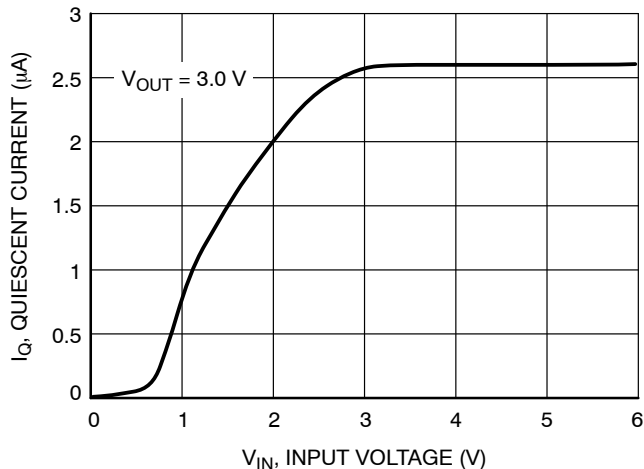

Figure 4. Quiescent Current versus Input Voltage

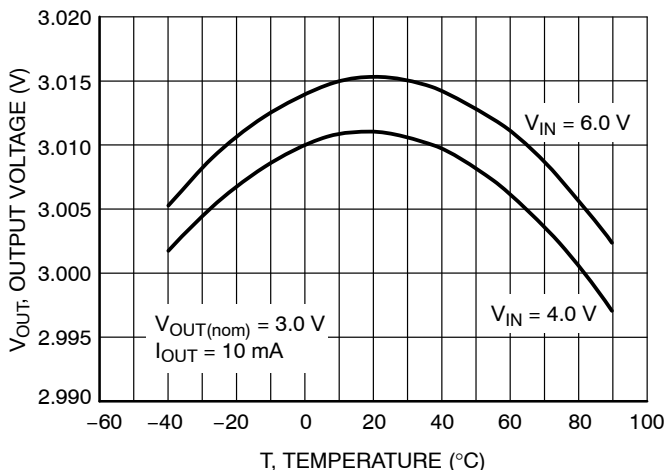

Figure 5. Output Voltage versus Temperature

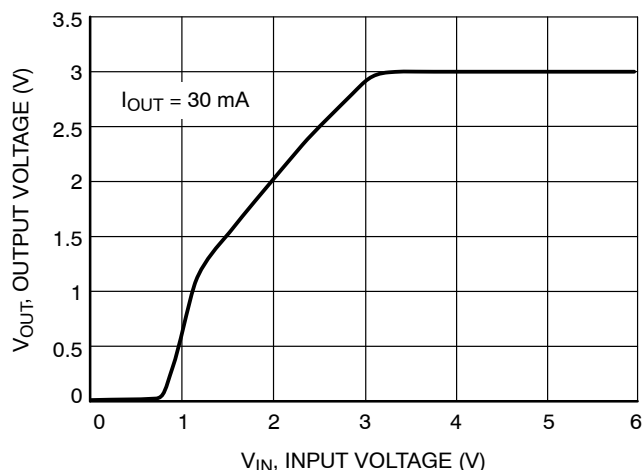

Figure 6. Output Voltage versus Input Voltage

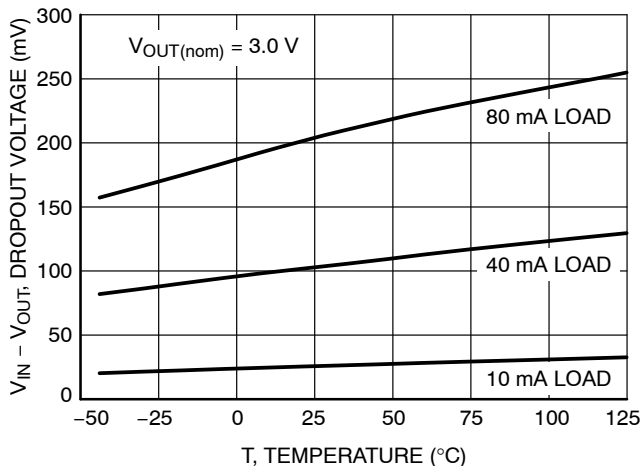

Figure 7. Dropout Voltage versus Temperature

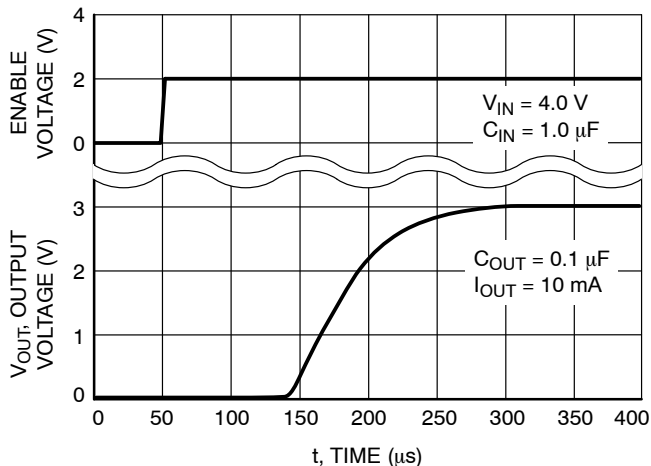

Figure 8. Turn-On Response (NCP662/NCV662 ONLY)

NCP662, NCV662, NCP663, NCV663

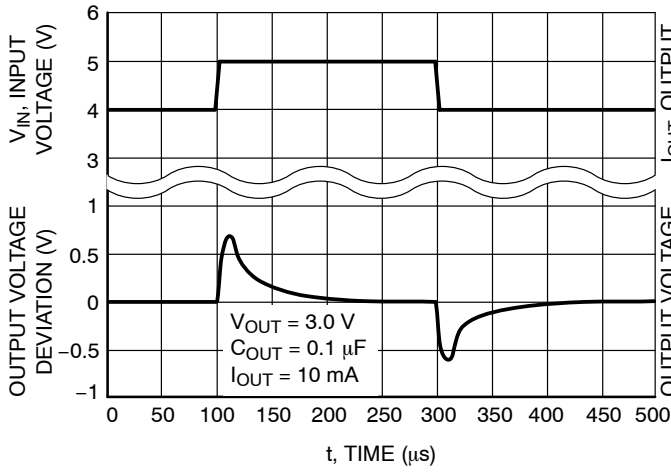

Figure 9. Line Transient Response

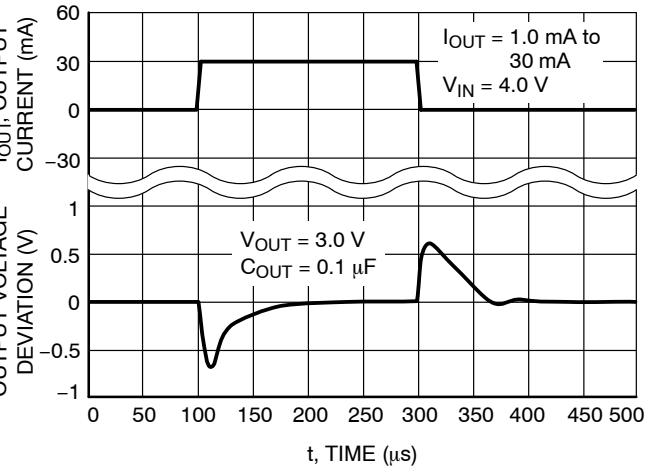

Figure 10. Load Transient Response

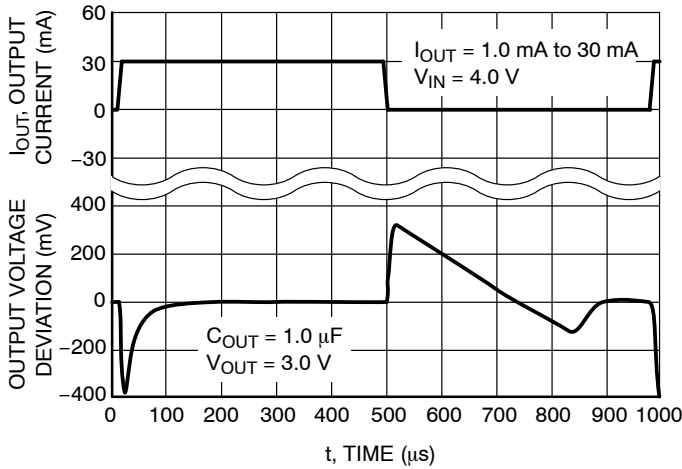

Figure 11. Load Transient Response

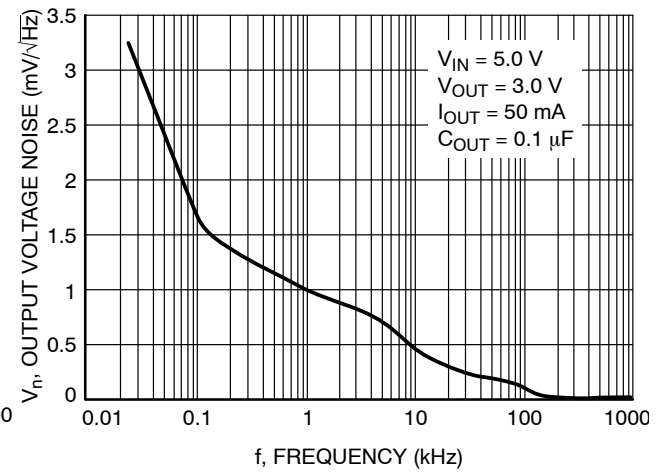

Figure 12. Output Voltage Noise

DEFINITIONS

Load Regulation

The change in output voltage for a change in output current at a constant temperature.

Dropout Voltage

The input/output differential at which the regulator output no longer maintains regulation against further reductions in input voltage. Measured when the output drops 3.0% below its nominal. The junction temperature, load current, and minimum input supply requirements affect the dropout level.

Maximum Power Dissipation

The maximum total dissipation for which the regulator will operate within its specifications.

Quiescent Current

The quiescent current is the current which flows through the ground when the LDO operates without a load on its output: internal IC operation, bias, etc. When the LDO becomes loaded, this term is called the Ground current. It is actually the difference between the input current (measured through the LDO input pin) and the output current.

Line Regulation

The change in output voltage for a change in input voltage. The measurement is made under conditions of low dissipation or by using pulse technique such that the average chip temperature is not significantly affected.

Line Transient Response

Typical over and undershoot response when input voltage is excited with a given slope.

Thermal Protection

Internal thermal shutdown circuitry is provided to protect the integrated circuit in the event that the maximum junction temperature is exceeded. When activated at typically 160°C, the regulator turns off. This feature is provided to prevent failures from accidental overheating.

Maximum Package Power Dissipation

The maximum power package dissipation is the power dissipation level at which the junction temperature reaches its maximum operating value, i.e. 125°C. Depending on the ambient power dissipation and thus the maximum available output current.

NCP662, NCV662, NCP663, NCV663

APPLICATIONS INFORMATION

A typical application circuit for the NCP662/NCV662 and NCP663/NCV663 series are shown in Figure 1 and Figure 2.

Input Decoupling (C1)

A 1.0 μF capacitor, either ceramic or tantalum is recommended and should be connected close to the device package. Higher capacitance values and lower ESR will improve the overall line transient response.

TDK capacitor: C2012X5R1C105K or C1608X5R1A105K

Output Decoupling (C2)

The NCP662/NCV662 and NCP663/NCV663 are very stable regulators and do not require any specific Equivalent Series Resistance (ESR) or a minimum output current. Capacitors exhibiting ESRs ranging from a few $\text{m}\Omega$ up to $10\ \Omega$ can safely be used. The minimum decoupling value is $0.1\ \mu\text{F}$ and can be augmented to fulfill stringent load transient requirements. The regulator accepts ceramic chip capacitors as well as tantalum devices. Larger values improve noise rejection and load regulation transient response.

TDK capacitor: C2012X5R1C105K, C1608X5R1A105K, or C3216X7R1C105K

Enable Operation (NCP662/NCV662 ONLY)

The enable pin will turn on the regulator when pulled high and turn off the regulator when pulled low. The threshold limits are covered in the electrical specification section of the data sheet. If the enable is not used, the pin should be connected to V_{in} .

Hints

Please be sure the V_{in} and GND lines are sufficiently wide. When the impedance of these lines is high, there is a chance to pick up noise or cause the regulator to malfunction.

Place external components, especially the output capacitor, as close as possible to the circuit, and make leads as short as possible.

Thermal

As power across the NCP662/NCV662 and NCP663/NCV663 increases, it might become necessary to provide some thermal relief. The maximum power dissipation supported by the device is dependent upon board design and layout. The mounting pad configuration on the PCB, the board material, and the ambient temperature effect the rate of temperature rise for the part. This is stating that when the devices have good thermal conductivity through the PCB, the junction temperature will be relatively low with high power dissipation applications.

The maximum dissipation the package can handle is given by:

$$PD = \frac{T_{J(\text{max})} - T_A}{R_{\theta JA}}$$

If junction temperature is not allowed above the maximum 125°C , then the NCP662/NCV662 and NCP663/NCV663 can dissipate up to $300\ \text{mW}$ @ 25°C .

The power dissipated by the NCP662/NCV662 and NCP663/NCV663 can be calculated from the following equation:

$$P_{\text{tot}} = [V_{\text{in}} * I_{\text{gnd}} (I_{\text{out}})] + [V_{\text{in}} - V_{\text{out}}] * I_{\text{out}}$$

or

$$V_{\text{inMAX}} = \frac{P_{\text{tot}} + V_{\text{out}} * I_{\text{out}}}{I_{\text{gnd}} + I_{\text{out}}}$$

If an $100\ \text{mA}$ output current is needed then the ground current from the data sheet is $2.5\ \mu\text{A}$. For the NCP662/NCV662 or NCP663/NCV663 ($3.0\ \text{V}$), the maximum input voltage is $6.0\ \text{V}$.

NCP662, NCV662, NCP663, NCV663

ORDERING INFORMATION

Device	Nominal Output Voltage	Marking	Package	Shipping†
NCP662SQ15T1	1.5	LGY	SC82-AB	3000 Units/ 8" Tape & Reel
NCP662SQ15T1G	1.5	LGY		
NCP662SQ18T1	1.8	LGZ		
NCP662SQ18T1G	1.8	LGZ		
NCP662SQ25T1	2.5	LHA		
NCP662SQ25T1G	2.5	LHA		
NCP662SQ27T1	2.7	LHB		
NCP662SQ27T1G	2.7	LHB		
NCP662SQ28T1	2.8	LHC		
NCP662SQ28T1G	2.8	LHC		
NCP662SQ30T1	3.0	LHD		
NCP662SQ30T1G	3.0	LHD		
NCP662SQ33T1	3.3	LHE		
NCP662SQ33T1G	3.3	LHE		
NCP662SQ50T1	5.0	LHF		
NCP662SQ50T1G	5.0	LHF		
NCP663SQ15T1	1.5	LHG	SC82-AB	3000 Units/ 8" Tape & Reel
NCP663SQ15T1G	1.5	LHG		
NCP663SQ18T1	1.8	LHH		
NCP663SQ18T1G	1.8	LHH		
NCP663SQ25T1	2.5	LHI		
NCP663SQ25T1G	2.5	LHI		
NCP663SQ27T1	2.7	LHJ		
NCP663SQ27T1G	2.7	LHJ		
NCP663SQ28T1	2.8	LHK		
NCP663SQ28T1G	2.8	LHK		
NCP663SQ30T1	3.0	LHL		
NCP663SQ30T1G	3.0	LHL		
NCP663SQ33T1	3.3	LHM		
NCP663SQ33T1G	3.3	LHM		
NCP663SQ50T1	5.0	LHN		
NCP663SQ50T1G	5.0	LHN		

†For information on tape and reel specifications, including part orientation and tape sizes, please refer to our Tape and Reel Packaging Specifications Brochure, BRD8011/D.

NCP662, NCV662, NCP663, NCV663

ORDERING INFORMATION

Device	Nominal Output Voltage	Marking	Package	Shipping†
NCV662SQ15T1	1.5	LGY	SC82-AB	3000 Units/ 8" Tape & Reel
NCV662SQ15T1G	1.5	LGY		
NCV662SQ18T1	1.8	LGZ		
NCV662SQ18T1G	1.8	LGZ		
NCV662SQ25T1	2.5	LHA		
NCV662SQ25T1G	2.5	LHA		
NCV662SQ27T1	2.7	LHB		
NCV662SQ27T1G	2.7	LHB		
NCV662SQ28T1	2.8	LHC		
NCV662SQ28T1G	2.8	LHC		
NCV662SQ30T1	3.0	LHD		
NCV662SQ30T1G	3.0	LHD		
NCV662SQ33T1	3.3	LHE		
NCV662SQ33T1G	3.3	LHE		
NCV662SQ50T1	5.0	LHF		
NCV662SQ50T1G	5.0	LHF		
NCV663SQ15T1	1.5	LHG	SC82-AB	3000 Units/ 8" Tape & Reel
NCV663SQ15T1G	1.5	LHG		
NCV663SQ18T1	1.8	LHH		
NCV663SQ18T1G	1.8	LHH		
NCV663SQ25T1	2.5	LHI		
NCV663SQ25T1G	2.5	LHI		
NCV663SQ27T1	2.7	LHJ		
NCV663SQ27T1G	2.7	LHJ		
NCV663SQ28T1	2.8	LHK		
NCV663SQ28T1G	2.8	LHK		
NCV663SQ30T1	3.0	LHL		
NCV663SQ30T1G	3.0	LHL		
NCV663SQ33T1	3.3	LHM		
NCV663SQ33T1G	3.3	LHM		
NCV663SQ50T1	5.0	LHN		
NCV663SQ50T1G	5.0	LHN		

†For information on tape and reel specifications, including part orientation and tape sizes, please refer to our Tape and Reel Packaging Specifications Brochure, BRD8011/D.

NCP662, NCV662, NCP663, NCV663

PACKAGE DIMENSIONS

SC-82AB CASE 419C-02 ISSUE E

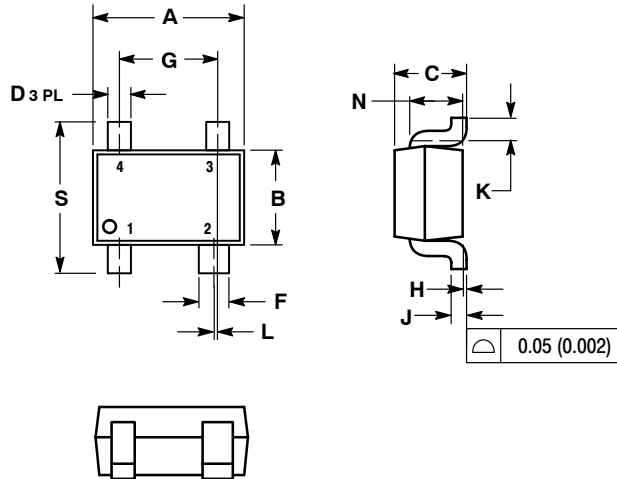

NOTES:

1. DIMENSIONING AND TOLERANCING PER ANSI Y14.5M, 1982.
2. CONTROLLING DIMENSION: MILLIMETER.
3. 419C-01 OBSOLETE. NEW STANDARD IS 419C-02.
4. DIMENSIONS A AND B DO NOT INCLUDE MOLD FLASH, PROTRUSIONS, OR GATE BURRS.

DIM	MILLIMETERS		INCHES	
	MIN	MAX	MIN	MAX
A	1.8	2.2	0.071	0.087
B	1.15	1.35	0.045	0.053
C	0.8	1.1	0.031	0.043
D	0.2	0.4	0.008	0.016
F	0.3	0.5	0.012	0.020
G	1.1	1.5	0.043	0.059
H	0.0	0.1	0.000	0.004
J	0.10	0.26	0.004	0.010
K	0.1	---	0.004	---
L	0.05 BSC		0.002 BSC	
N	0.2 REF		0.008 REF	
S	1.8	2.4	0.07	0.09

SOLDERING FOOTPRINT*

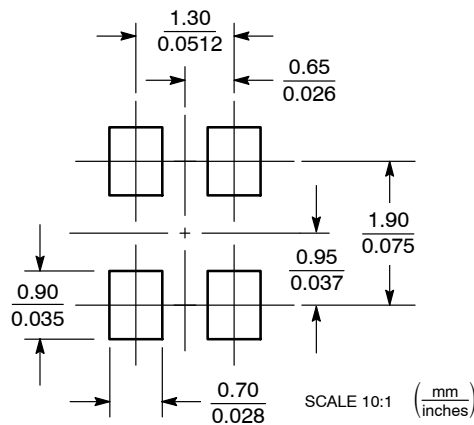

*For additional information on our Pb-Free strategy and soldering details, please download the ON Semiconductor Soldering and Mounting Techniques Reference Manual, SOLDERRM/D.

ON Semiconductor and are registered trademarks of Semiconductor Components Industries, LLC (SCILLC). SCILLC reserves the right to make changes without further notice to any products herein. SCILLC makes no warranty, representation or guarantee regarding the suitability of its products for any particular purpose, nor does SCILLC assume any liability arising out of the application or use of any product or circuit, and specifically disclaims any and all liability, including without limitation special, consequential or incidental damages. "Typical" parameters which may be provided in SCILLC data sheets and/or specifications can and do vary in different applications and actual performance may vary over time. All operating parameters, including "Typicals" must be validated for each customer application by customer's technical experts. SCILLC does not convey any license under its patent rights nor the rights of others. SCILLC products are not designed, intended, or authorized for use as components in systems intended for surgical implant into the body, or other applications intended to support or sustain life, or for any other application in which the failure of the SCILLC product could create a situation where personal injury or death may occur. Should Buyer purchase or use SCILLC products for any such unintended or unauthorized application, Buyer shall indemnify and hold SCILLC and its officers, employees, subsidiaries, affiliates, and distributors harmless against all claims, costs, damages, and expenses, and reasonable attorney fees arising out of, directly or indirectly, any claim of personal injury or death associated with such unintended or unauthorized use, even if such claim alleges that SCILLC was negligent regarding the design or manufacture of the part. SCILLC is an Equal Opportunity/Affirmative Action Employer. This literature is subject to all applicable copyright laws and is not for resale in any manner.

PUBLICATION ORDERING INFORMATION

LITERATURE FULFILLMENT:
Literature Distribution Center for ON Semiconductor
P.O. Box 5163, Denver, Colorado 80217 USA
Phone: 303-675-2175 or 800-344-3860 Toll Free USA/Canada
Fax: 303-675-2176 or 800-344-3867 Toll Free USA/Canada
Email: orderlit@onsemi.com

N. American Technical Support: 800-282-9855 Toll Free
USA/Canada
Europe, Middle East and Africa Technical Support:
Phone: 421 33 790 2910
Japan Customer Focus Center
Phone: 81-3-5773-3850

ON Semiconductor Website: www.onsemi.com

Order Literature: <http://www.onsemi.com/orderlit>

For additional information, please contact your local Sales Representative