

AIMB-582

**Intel® Xeon® E3/Core™ i7/i5/i3
LGA1155 MicroATX with CRT/
DVI/eDP/LVDS/DP, 6 COM, Dual
LAN, DDR3, PCIe x 16 and
SATAIII**

Copyright

The documentation and the software included with this product are copyrighted 2012 by Advantech Co., Ltd. All rights are reserved. Advantech Co., Ltd. reserves the right to make improvements in the products described in this manual at any time without notice.

No part of this manual may be reproduced, copied, translated or transmitted in any form or by any means without the prior written permission of Advantech Co., Ltd. Information provided in this manual is intended to be accurate and reliable. However, Advantech Co., Ltd. assumes no responsibility for its use, nor for any infringements of the rights of third parties, which may result from its use.

Acknowledgements

IBM and PC are trademarks of International Business Machines Corporation.

Intel® Core™ i7/i5/i3 Celeron® is trademark of Intel Corporation

All other product names or trademarks are properties of their respective owners.

A Message to the Customer

Advantech Customer Services

Each and every Advantech product is built to the most exacting specifications to ensure reliable performance in the harsh and demanding conditions typical of industrial environments. Whether your new Advantech equipment is destined for the laboratory or the factory floor, you can be assured that your product will provide the reliability and ease of operation for which the name Advantech has come to be known.

Your satisfaction is our primary concern. Here is a guide to Advantech's customer services. To ensure you get the full benefit of our services, please follow the instructions below carefully.

Technical Support

We want you to get the maximum performance from your products. So if you run into technical difficulties, we are here to help. For the most frequently asked questions, you can easily find answers in your product documentation. These answers are normally a lot more detailed than the ones we can give over the phone.

So please consult this manual first. If you still cannot find the answer, gather all the information or questions that apply to your problem, and with the product close at hand, call your dealer. Our dealers are well trained and ready to give you the support you need to get the most from your Advantech products. In fact, most problems reported are minor and are able to be easily solved over the phone.

In addition, free technical support is available from Advantech engineers every business day. We are always ready to give advice on application requirements or specific information on the installation and operation of any of our products.

Declaration of Conformity

FCC Class B

This device complies with the requirements in part 15 of the FCC rules:

Operation is subject to the following two conditions:

- This device may not cause harmful interference
- This device must accept any interference received, including interference that may cause undesired operation.

This equipment has been tested and found to comply with the limits for a Class B digital device, pursuant to Part 15 of the FCC Rules. These limits are designed to provide reasonable protection against harmful interference when the equipment is operated in a commercial environment. This equipment generates, uses, and can radiate radio frequency energy and, if not installed and used in accordance with the instruction manual, may cause harmful interference to radio communications. Operation of this device in a residential area is likely to cause harmful interference in which case the user will be required to correct the interference at his/her own expense. The user is advised that any equipment changes or modifications not expressly approved by the party responsible for compliance would void the compliance to FCC regulations and therefore, the user's authority to operate the equipment.

Caution! *There is a danger of a new battery exploding if it is incorrectly installed. Do not attempt to recharge, force open, or heat the battery. Replace the battery only with the same or equivalent type recommended by the manufacturer. Discard used batteries according to the manufacturer's instructions.*



CPU Compatibility

CPU Family	Spec.	Core Stepping	Freq (GHz)	Power	FSB	Mfg. Tech	Core/Thread	H/T	L2 cache	L3 cache	Package Type	Result
Intel Sandy bridge (Xeon) E3-1275 3.4 GHz	SR00P		3.4	95W		32nm	4/8	V	NA	8MB	LGA1155	PASS
Intel Sandy bridge (Xeon) E3-1225 3.1 GHz	SR00G		3.1	95W		32nm	4/4		NA	6MB	LGA1155	PASS
Intel Ivy Bridge Core i7-3770-3.4 (QS)	QC1W	QS	3.4	95W		22nm	4/8	V	NA	8MB	LGA1155	PASS
Intel Ivy Bridge Core i5-3550S-3.0 (QS)	QC14	QS	3	65W		22nm	4/4		NA	6MB	LGA1155	PASS
Intel Ivy Bridge Core i3-3220 3.3 G (QS)	QC8H	QS	3.3	65W		22nm	2/4	V	NA	3MB	LGA1155	PASS
Intel®Core® i7-2600 Processor 3.4 GHz	SR00B	D2	3.4	95W		32nm	4/8	V	NA	8MB	LGA1155	PASS
Intel® Core® i5-2400 Processor 3.1 GHz	SR00Q	D2	3.1	95W		32nm	4/4		NA	6MB	LGA1155	PASS
Intel® Core® i3-2120 Processor 3.3 GHz	SR05Y	Q0	3.3	65W		32nm	2/4	V	NA	3MB	LGA1155	PASS
Intel® Celeron® Processor G540 2.50 GHz	SR05J		2.5	65W		32nm	2/2		NA	2MB	LGA1155	PASS
Intel® Pentium® Processor G850 2.90 GHz	SR05Q		2.9	65W		32nm	2/2		NA	3MB	LGA1155	PASS

Memory Compatibility

	Size	Speed	Type	ECC	Vendor PN	Memory	Result
Transcend	1GB	DDR3 1066	DDR3	N	TS128MLK64V1U	SEC K4B1G0846G-BCH9	pass
Transcend	2GB	DDR3 1066	DDR3	N	TS256MLK64V1U	SEC K4B1G0846G-BCH9	pass
Apacer	1GB	DDR3 1066	DDR3	N	78.01GC3.420	ELPIDA J1108BDBG-DJ-F (128x8)	pass
Apacer	2GB	DDR3 1066	DDR3	N	78.A1GC3.421	ELPIDA J1108BDBG-DJ-F (128x8)	pass
Apacer	4GB	DDR3 1066	DDR3	N	78.B1GDJ.AF1	HYNIX H5TQ2G83BFR-H9C	pass
Transcend	1GB	DDR3 1333	DDR3	N	TS128MLK64V3U	ELPIDA EDJ1108BFBG-DJ-F	pass
Transcend	2GB	DDR3 1333	DDR3	N	TS256MLK64V3U	SEC K4B1G0846G-BCH9	pass
Transcend	8GB	DDR3 1333	DDR3	N	TS1GLK64V3H	MICRON IWD27 D9PBC	pass
Apacer	1GB	DDR3 1333	DDR3	N	78.01GC6.AF0	H5TQ1G83DFR-H9C	pass
						H5TQ1G83TFR-H9C	pass
Apacer	2GB	DDR3 1333	DDR3	N	78.A1GDE.4200C	ELPIDA J2108BCSE-DJ-F	pass
Apacer	2GB	DDR3 1333	DDR3	N	78.A1GDE.AF00C	Hynix H5TQ2G838FR(256x8)	pass
Apacer	4GB	DDR3 1333	DDR3	N	78.B1GDE.AF1	HYNIX H5TQ2G83BFR-H9C	pass
Kingston	2GB	DDR3 1333	DDR3	N	KVR1333D3S8N9/2G	ELPIDA J2108BCSE-DJ-F(128x8)	pass
Kingston	4GB	DDR3 1333	DDR3	N	KVR1333D3N9/4G	KINGSTON D2568JENC PGD9U(512x64)	pass
DSL	2GB	DDR3 1600	DDR3	N	D3US56081XH12AA	SEC 113 HCK0 K4B2G0846C 256x8	pass
DSL	4GB	DDR3 1600	DDR3	N	D3US56082XH12AA	SEC 113 HCK0 K4B2G0846C 256x8	pass
Transcend	4GB	DDR3 1600	DDR3	N	TS512MLK64V6N	MICRON IUM22 D9PFJ	pass
Transcend	2GB	DDR3 1600	DDR3	N	TS256MLK64V6N	MICRON IRM72 D9PFJ	pass
Transcend	8GB	DDR3 1600	DDR3	N			pass
Transcend	8GB	DDR3 1600	DDR3	N			pass

Ordering Information

Part Number	Chipset	Memory	USB 3.0	VGA	DVI	DP	LVDS /eDP	USB	COM	TPM	GbE LAN
AIMB-582QG2-00A1E	Q77	Non- ECC	4	1	1	1	1/(1)	8	6	(1)	2
AIMB-582WG2-00A1E	C216	ECC/ Non- ECC	4	1	1	1	1/(1)	8	6	(1)	2

*() means do not populated on MP version.

Product Warranty (2 years)

Advantech warrants to you, the original purchaser, that each of its products will be free from defects in materials and workmanship for two years from the date of purchase.

This warranty does not apply to any products which have been repaired or altered by persons other than repair personnel authorized by Advantech, or which have been subject to misuse, abuse, accident or improper installation. Advantech assumes no liability under the terms of this warranty as a consequence of such events.

Because of Advantech's high quality-control standards and rigorous testing, most of our customers never need to use our repair service. If an Advantech product is defective, it will be repaired or replaced at no charge during the warranty period. For out-of-warranty repairs, you will be billed according to the cost of replacement materials, service time and freight. Please consult your dealer for more details.

If you think you have a defective product, follow these steps:

1. Collect all the information about the problem encountered. (For example, CPU speed, Advantech products used, other hardware and software used, etc.) Note anything abnormal and list any onscreen messages you get when the problem occurs.
2. Call your dealer and describe the problem. Please have your manual, product, and any helpful information readily available.
3. If your product is diagnosed as defective, obtain an RMA (return merchandise authorization) number from your dealer. This allows us to process your return more quickly.
4. Carefully pack the defective product, a fully-completed Repair and Replacement Order Card and a photocopy proof of purchase date (such as your sales receipt) in a shippable container. A product returned without proof of the purchase date is not eligible for warranty service.
5. Write the RMA number visibly on the outside of the package and ship it prepaid to your dealer.

Initial Inspection

Before you begin installing your motherboard, please make sure that the following materials have been shipped:

- 1 x AIMB-582 Intel LGA 1155 Xeon E3 & Core i7/i5/i3 Micro ATX Motherboard
- 2 x SATA HDD cable
- 2 x SATA Power cable
- 1 x I/O port bracket
- 1 x Startup manual
- 1 x Driver CD
- 1 x Warranty card

If any of these items are missing or damaged, contact your distributor or sales representative immediately. We have carefully inspected the AIMB-582 mechanically and electrically before shipment. It should be free of marks and scratches and in perfect working order upon receipt. As you unpack the AIMB-582, check it for signs of shipping damage. (For example, damaged box, scratches, dents, etc.) If it is damaged or it fails to meet the specifications, notify our service department or your local sales representative immediately. Also notify the carrier. Retain the shipping carton and packing material for inspection by the carrier. After inspection, we will make arrangements to repair or replace the unit.

Contents

Chapter 1 General Information1

1.1	Introduction	2
1.2	Features	2
1.3	Specifications	2
1.3.1	System	2
1.3.2	Memory	2
1.3.3	Input/Output	3
1.3.4	Graphics.....	3
1.3.5	Ethernet LAN	3
1.3.6	Industrial features	3
1.3.7	Mechanical and environmental specifications.....	3
1.4	Jumpers and Connectors	4
	Table 1.1: Jumpers.....	4
	Table 1.2: Connectors	4
1.5	Board layout: Jumper and Connector Locations	6
	Figure 1.1 Jumper and Connector Location	6
	Figure 1.2 I/O Connectors	6
1.6	AIMB-582 Board Diagram	7
	Figure 1.3 AIMB-582 Block Diagram	7
1.7	Safety Precautions	8
1.8	Jumper Settings	8
1.8.1	How to Set Jumpers.....	8
1.8.2	CMOS Clear (CMOS1)	9
	Table 1.3: CMOS1	9
1.8.3	JLVDS1-2: LCD Power 3.3 V/ 5 V/ 12 V Selector	9
	Table 1.4: JLVDS1-2: LCD Power 3.3 V/5 V/ 12 V Selector	9
1.8.4	JUSBPWR1-4 (USB Power Selection Connector).....	10
	Table 1.5: JUSBPWR1-4 (USB Power Selection Connector) ...	10
1.8.5	PSON1: ATX, AT Mode Selector	10
	Table 1.6: PSON1: ATX, AT Mode Selector.....	10
1.8.6	JIR1+JOB1+JWD1: Watchdog Timer Output and OBS Alarm Option	10
	Table 1.7: JIR1+JOB1+JWD1: Watchdog Timer Output and OBS Alarm Option.....	10
1.8.7	JME1:BIOS Update ME Mode Selector	11
	Table 1.8: BIOS update ME mode selector	11
1.8.8	JCASE1: Case Open Sensor.....	11
1.9	System Memory	11
1.10	Memory Installation Procedures.....	12
1.11	Cache Memory.....	12
1.12	Processor Installation	12
1.13	PCI Bus Routing Table.....	12

Chapter 2 Connecting Peripherals13

2.1	Introduction	14
2.2	USB Ports (LAN1_USB01/LAN2_USB23/USB45/USB89/USB1011/ USB1213).....	14
	Table 2.1: LAN LED Indicator.....	14
2.3	USB Power Switch	15
2.4	VGA/DVI-D Connector (VGA1+DVI 1) Connector.....	16
2.5	Serial Ports (COM1~COM6)	17
2.6	Display Port (DP1)	18
2.7	PS/2 Keyboard and Mouse Connector (KBMS1)/External PS/2 Keyboard	

	and Mouse Connector (KBMS2)	19
2.8	CPU Fan Connector (CPU_FAN1)	20
2.9	System FAN Connector (SYSFAN1/2/3/4)	20
2.10	Front Panel Connectors (JFP1/JFP2/JFP3)	21
	2.10.1 ATX soft power switch ((JFP1/PWR_SW)).....	21
	2.10.2 Reset (JFP1/RESET).....	21
	2.10.3 HDD LED (JFP1/HDDLED)	21
	2.10.4 External speaker (JFP1/SPEAKER).....	21
	2.10.5 Power LED and keyboard lock connector (JFP3/PWR_LED & KEY LOCK).....	22
	Table 2.2: ATX power supply LED status (No support for AT power).....	22
2.11	Line Out, Mic In Connector (AUDIO1)	22
2.12	Digital Audio Connector (SPDIF_OUT1).....	23
2.13	Serial ATA Interface (SATA1 ~ SATA6).....	24
2.14	8-pin Alarm Board Connector (VOLT1).....	25
2.15	PCI express x16 slot	25
2.16	Front Panel Audio Connector (FPAUD1)	26
2.17	ATX Power Connector (EATXPWR1, ATX12V1).....	27
2.18	SPI Flash connector(SPI_CN1)	28
2.19	LVDS Inverter Connector (INV1)	29
2.20	LVDS Connector (LVDS1)	30
2.21	General purpose I/O Connector (GPIO1)	30
2.22	eDP Connector (eDP1).....	31
2.23	JTAG Connector (JTAG1).....	31

Chapter 3 BIOS Operation 33

3.1	Introduction	34
3.2	BIOS Setup	34
	3.2.1 Main Menu	35
	3.2.2 Advanced BIOS Features	36
3.3	Chipset Configuration Setting	55
	3.3.1 PCH-IO Configuration.....	55
	3.3.2 System Agent (SA) Configuration.....	60
3.4	Boot Setting	65
3.5	Security Setting.....	66
3.6	Save & Exit Configuration	67

Chapter 4 Software Introduction & Service 69

4.1	Introduction	70
4.2	Value-Added Software Services	70
	4.2.1 Software API.....	70
	4.2.2 Software Utility.....	72

Chapter 5 Chipset Software Installation Utility 73

5.1	Before You Begin	74
5.2	Introduction	74
5.3	Windows XP/Windows 7 Driver Setup	75

Chapter 6 VGA Setup 77

6.1	Introduction	78
6.2	Windows 7/XP.....	78

Chapter	7	LAN Configuration.....	81
7.1		Introduction	82
7.2		Features	82
7.3		Installation	82
7.4		Windows® 7/XP Driver Setup (Intel 82579LM/82583V).....	83
Appendix A		Programming the Watchdog Timer..	85
A.1		Programming the Watchdog Timer	86
A.1.1		Watchdog Timer Overview.....	86
A.1.2		Programming the Watchdog Timer	86
		Table A.1: Watchdog Timer Registers	88
A.1.3		Example Program	89
Appendix B		Pin Assignments	93
B.1		USB Header (USB45,USB89,USB1011,USB1213).....	94
		Table B.1: USB Header (USB56).....	94
B.2		VGA Connector (VGA1).....	94
		Table B.2: VGA Connector (VGA1)	94
B.3		eDP1: eDP Connector.....	95
		Table B.3: eDP1: eDP Connector	95
B.4		SPI_CN1: SPI Fresh Card Pin Connector.....	95
		Table B.4: SPI_CN1: SPI Fresh Card Pin Connector	95
B.5		PS/2 Keyboard and Mouse Connector (KBMS1).....	96
		Table B.5: PS/2 Keyboard and Mouse Connector (KBMS1)	96
B.6		RS-232 Interface (COM3/4/5/6)	96
		Table B.6: RS-232 Interface (COM3/4/5/6).....	97
B.7		CPU Fan Power Connector (CPU_FAN1)	97
		Table B.7: CPU Fan Power Connector (CPU_FAN1).....	97
B.8		System Fan Power Connector (SYS_FAN1/2/3/4)	98
		Table B.8: System Fan Power Connector (SYSFAN1/SYSFAN2/ SYSFAN3/SYSFAN4).....	98
B.9		Power LED & Keyboard Lock Connector (JFP3)	98
		Table B.9: Power LED & Keyboard Lock Connector (JFP3).....	98
B.10		Power Switch/HDD LED/SMBus/Speaker (JFP1/2).....	99
		Table B.10:Power switch/HDD LED/SMBus/Speaker (JFP1/2)..	99
B.11		USB/LAN ports (LAN1_USB12/LAN2_USB34).....	99
		Table B.11:USB Port.....	99
		Table B.12:Ethernet 10/100 Mbps RJ-45 Port	99
B.12		Line Out, Mic In Connector (AUDIO1).....	100
B.13		Serial ATA0/1 (SATA1 ~ 6)	100
		Table B.13:Serial ATA 0/1 (SATA1 ~ 6)	100
B.14		AT/ATX Mode (PSON1)	100
		Table B.14:AT/ATX Mode (PSON1)	100
B.15		HD Audio Interface (FPAUD1)	100
		Table B.15:HD Audio Interface (FPAUD1).....	100
B.16		GPIO Pin Header (GPIO1).....	101
		Table B.16:GPIO Pin Header (GPIO1)	101
B.17		LVDS Connector: LVDS1	101
		Table B.17:LVDS Connector: LVDS1	101
B.18		LVDS Power Jumper (JLVDS1/2).....	102
		Table B.18:LVDS Power Jumper	102
B.19		LVDS Inverter (INV1)	102
		Table B.19:LVDS Inverter (INV1).....	102
B.20		ATX Power Connector (ATXPWR1, EATPWR1)	103
		Table B.20:ATX Power Connector (ATXPWR1, EATPWR1)....	103

B.21	ATX 12 V Connector (ATX12V1)	104
	Table B.21:ATX 12 V Connector (ATX12V1).....	104
B.22	JTAG (Joint Test Action Group Connector)	104
	Table B.22:Joint Test Action Group (JTAG)	104
B.23	JUSBPWR1-4 (USB Power Selection Connector).....	104
	Table B.23:JUSBPWR1-4 (USB Power Selection Connector) .	104
B.24	DMA Channel Assignments	105
	Table B.24:DMA Channel Assignments	105
B.25	Interrupt Assignments	105
	Table B.25:Interrupt Assignments	105
B.26	1st MB Memory Map	105
	Table B.26:1st MB Memory Map	105

Chapter 1

General Information

1.1 Introduction

AIMB-582 is designed with the Intel Q77/C216 for industrial applications that require both performance computing and enhanced power management capabilities. The motherboard supports Intel Core i7 3770 3.4GHz/ Core i5 3550S 3.0 GHz/ Core i3 3220 3.3 GHz/Pentium G850 2.9 GHz/Celeron G540 2.5 GHz processor up to 8 MB L3 cache and DDR3 1333/1600 up to 32GB up to 16 GB. A rich I/O connectivity of 6 serial ports, 8 USB 2.0, 4 USB 3.0, dual GbE LAN, 4 SATA II ports and 2 SATA III ports.

1.2 Features

- **Rich I/O connectivity:** Dual GbE LAN via PCIe x1 bus, 2 x PCI 32-bit/33 MHz PCI slots, 1 x PCIe x16 slot (Gen 3), 1 x PCIe x4 slot (Gen 2), 8 USB 2.0 ports and 4 USB 3.0 ports.
- **Standard Micro ATX form factor with industrial feature:** The AIMB-582 is a full featured Micro ATX motherboard with balanced expandability and performance.
- **Wide selection of storage devices:** SATA HDD, customers benefit from the flexibility of using the most suitable storage device for larger capacity.
- **Optimized integrated graphic solution:** With Intel® Flexible Display Interface, it supports versatile display options and 32-bit 3D graphics engine.

1.3 Specifications

1.3.1 System

- **CPU:** Intel Core i7 3770 3.4GHz/ Core i5 3550S 3.0GHz/ Core i3 3220 3.3GHz
- **BIOS:** AMI EFI 64 Mbit SPI BIOS
- **System chipset:** Intel® Q77/C216
- **SATA hard disk drive interface:** Four on-board SATA connectors with data transmission rate up to 300 MB, and two on-board SATA connectors with data transmission rate up to 600 MB

1.3.2 Memory

- **RAM:** Up to 32 GB in 4 slots 240-pin DIMM sockets. Supports dual-channel DDR3 1333/1600MHz SDRAM.
 - AIMB-582QG2 supports non-ECC unbuffered DIMMs and do not support any memory configuration that mixes non-ECC with ECC unbuffered DIMMs.
 - AIMB-582WG2 supports ECC buffered DIMMs.

Note! A 32-bit OS may not fully detected 4GB of RAM when 4 GB is installed.



1.3.3 Input/Output

- **PCIe slot:** 1 PCIe x16 expansion slot, 1 PCIe x4 expansion slot
- **PCI Bus:** 2 PCI slots, 32-bit/33 MHz PCI 2.2 compliant
- **Enhanced parallel port:** Configured to LPT1 or disabled. Standard DB-25 female connector cable is an optional accessory. LPT1 supports EPP/SPP/ECP.
- **Serial port:** Six serial ports, one is RS-232/422/485 with hardware auto-flow control and four are RS-232. One DB-9 connectors located in rear panel are RS-232.
- **Keyboard and PS/2 mouse connector:** Two 6-pin mini-DIN connectors are located on the mounting bracket for easy connection to PS/2 keyboard and mouse.
- **USB port:** Supports up to 8 USB 2.0 ports with transmission rates up to 480 Mbps and 4 USB 3.0 ports with transmission rates up to 5 Gbps.
- **GPIO:** AIMB-582 supports 8-bit GPIO from super I/O for general purpose control application.

1.3.4 Graphics

- **Controller:** Intel® HD Graphics
- **Display memory:** 1 GB maximum shared memory with 2GB and above system memory installed
- **DVI:** Supports DVI up to resolution 1920 x 1200 @ 60Hz refresh rate
- **VGA:** Supports VGA up to resolution 2048 x 1536 @ 75Hz refresh rate
- **LVDS:** Supports LVDS up to resolution 1920 x 1200
- **Display Port:** Support max resolution 2560 x 1600 @60Hz
- **eDP:** Support max resolution 1920 x 1200 @ 60Hz
- **Triple Display:** VGA + eDP (or LVDS)+ DP, VGA+eDP(or LVDS)+ DVI, VGA+DP+DVI
- **Dual Display:** VGA+eDP (or LVDS), VGA+DVI, eDP(or LVDS)+ DVI, VGA + DP, DP+ DVI, LVDS+DP

Note!  *If the triple display connects dongle, it must be DP signal output, or VGA+DP + (DVI or LVDS) will not support triple display. The triple display requires two are DP signal output. Please explain the DP limitation in real window in the manual.*

The default LVDS setting in BIOS is "disable", customer could enable this function manually, please see detail information in BIOS section.

1.3.5 Ethernet LAN

- Supports dual 10/100/1000 Mbps Ethernet port (s) via PCI Express x1 bus which provides 500 MB/s data transmission rate
- **Controller:** LAN1: Intel 82579LM; LAN2: Intel 82583V

1.3.6 Industrial features

- **Watchdog timer:** Can generate a system reset. The watchdog timer is programmable, with each unit equal to one second or one minute (255 levels)

1.3.7 Mechanical and environmental specifications

- **Operating temperature:** 0 ~ 60° C (32 ~ 140° F, Depending on CPU)
- **Storage temperature:** -40 ~ 85° C (-40 ~ 185° F)
- **Humidity:** 5 ~ 95% non-condensing

- **Power supply voltage:** +3.3 V, +5 V, +12 V, -12 V, 5 Vsb
- **Power consumption:**
 Intel LGA1155 Core i7 3770 3.4GHz, 8MB L3 Cache, 4pcs 8GB DDR3 1600MHz memory

+5 V	3.3 V	12 V	5 Vsb	-12 V
2.69 A	0.93 A	5.3 A	0.0 A	0.52 A

 Measure the maximum current value which system under maximum load (CPU: Top speed, RAM & Graphic: Full loading)
- **Board size:** 240 mm x 240 mm (9.6" x 9.6")
- **Board weight:** 0.365 kg

1.4 Jumpers and Connectors

Connectors on the AIMB-582 motherboard link it to devices such as hard disk drives and a keyboard. In addition, the board has a number of jumpers used to configure your system for your application.

The tables below list the function of each of the board jumpers and connectors. Later sections in this chapter give instructions on setting jumpers. Chapter 2 gives instructions for connecting external devices to your motherboard.

Table 1.1: Jumpers

Label	Function
JFP1	Power switch/HDD LED/SMBus/Speaker
JFP2	Power LED and Keyboard lock
CMOS1	CMOS clear (Default 1-2)
PSO1	AT(1-2) / ATX(2-3) (Default 2-3)
JWDT1+JOBS1	Watchdog Reset and OBS Alarm
JCASE1	Case Open pin header
JLVDS1	Voltage 3.3 V/5 V/12 V selector for LVDS1 connector (Default 1-2, 3.3 V)
JLVDS_CLT1	Brightness control selector for Analog or Digital (Default 1-2, Analog)
JEME1	Intel AMT Disable Jumper
JMECLR1	Clear AMT setting
JUSBPWR1	USB port 0-1 power source switch between +5 Vsb and +5 V
JUSBPWR2	USB port 2-3 power source switch between +5 Vsb and +5 V
JUSBPWR3	USB port 4/5/8/9 power source switch between +5 Vsb and +5 V
JUSBPWR4	USB port 10/11/12/13 power source switch between +5 Vsb and +5 V

Table 1.2: Connectors

Label	Function
LPT1	Parallel port, supports SPP/EPP/ECP mode
LVDS1	LVDS1 connector
INV1	LVDS1 inverter connector
COM3456	Serials port connector (RS-232)
USB45	USB port 4, 5 (on board)
USB89	USB port 8, 9 (on board)

Table 1.2: Connectors

USB1011	USB port 10, 11 (on board)
USB1213	USB port 12, 13 (on board)
VGA	VGA connector
COM1	Serial port connector(RS232)
KBMS1	PS/2 Keyboard and Mouse connector
CPUFAN1	CPU FAN connector(4-pin)
SYSFAN1	System FAN1 connector(3-pin)
SYSFAN2	System FAN2 connector(3-pin)
SYSFAN3	System FAN3 connector(3-pin)
SYSFAN4	System FAN4 connector(3-pin)
LAN1_USB01	LAN1 / USB port 0, 1
LAN2_USB23	LAN2 / USB port 2, 3
AUDIO1	Audio connector
SPDIF_OUT1	SPDIF Audio out pin header
FPAUD1	HD Audio Front Panel Pin Header
PCIEX16_1	PCIe x16 Slot
SATA1	Serial ATA data connector 1
SATA2	Serial ATA data connector 2
SATA3	Serial ATA data connector 3
SATA4	Serial ATA data connector 4
SATA5	Serial ATA data connector 5
SATA6	Serial ATA data connector 6
DIMMA1	Channel A DIMM1
SPI_CN1	SPI flash update connector.
GPIO1	GPIO header
ATX12V1	ATX 12V Auxiliary power connector (for CPU)
ATXPWR1	ATX 20 Pin Main power connector (for System)
DVI	DVI-D connector on rear panel
COM2	Serial Port COM2, pin header 2x5
EDP1	eDP connector (2x10 pin header)
JTAG	Joint Test Action Group connector 2x5 P
SMBUS1	SMBUS expansion pin header 1x4 P

1.5 Board layout: Jumper and Connector Locations

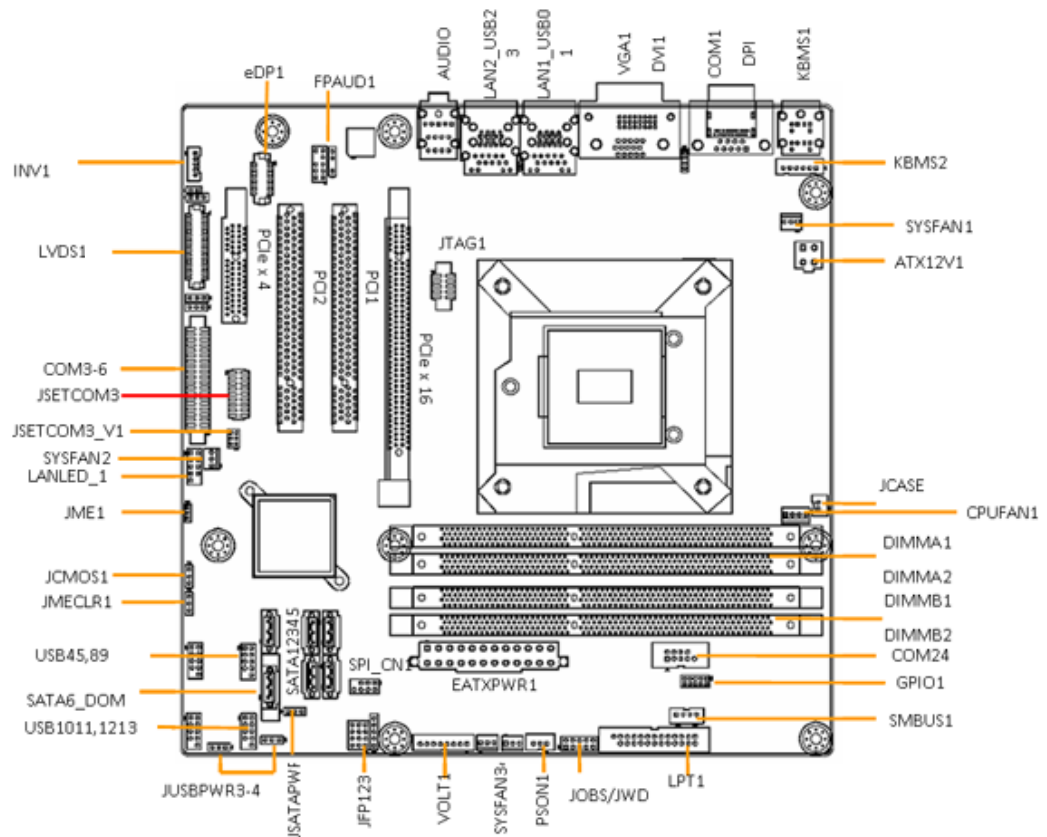

Figure 1.1 Jumper and Connector Location



Figure 1.2 I/O Connectors

1.6 AIMB-582 Board Diagram

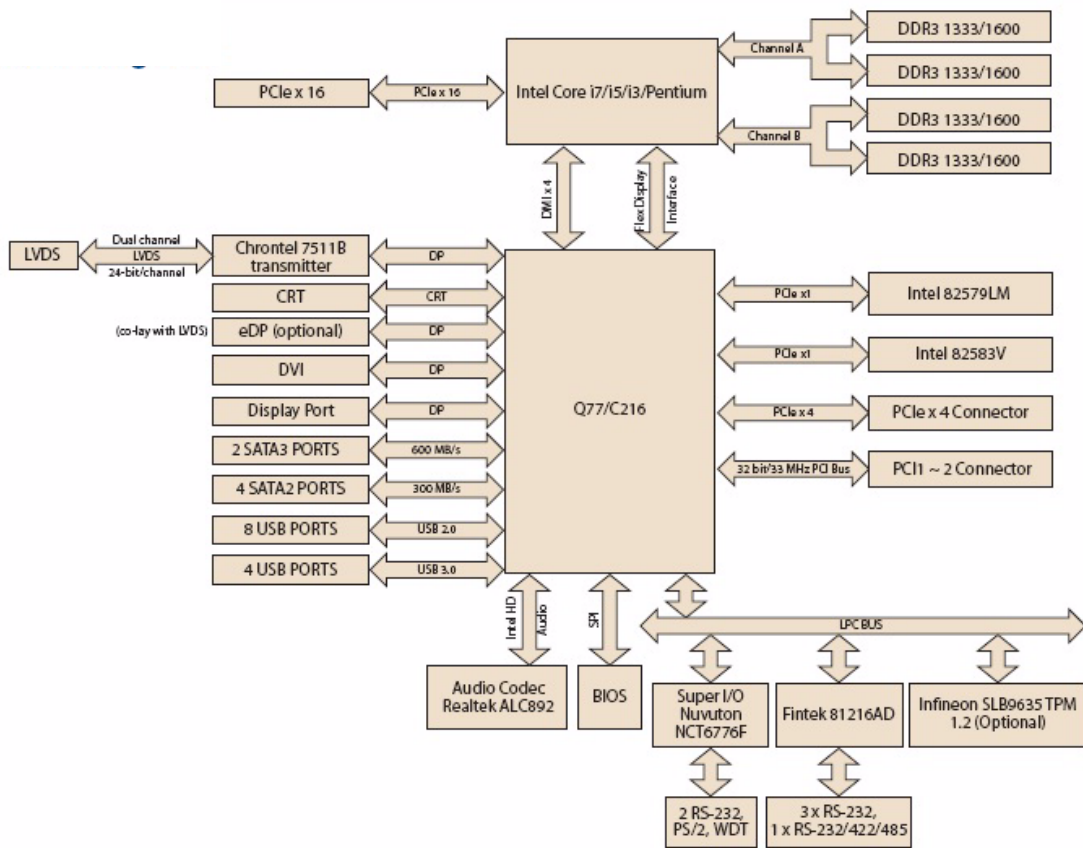

Figure 1.3 AIMB-582 Block Diagram

1.7 Safety Precautions

Warning! *Always completely disconnect the power cord from chassis whenever you work with the hardware. Do not make connections while the power is on. Sensitive electronic components can be damaged by sudden power surges. Only experienced electronics personnel should open the PC chassis.*



Caution! *Always ground yourself to remove any static charge before touching the motherboard. Modern electronic devices are very sensitive to electrostatic discharges. As a safety precaution, use a grounding wrist strap at all times. Place all electronic components on a static-dissipative surface or in a static-shielded bag when they are not in the chassis.*



Caution! *The computer is provided with a battery-powered real-time clock circuit. There is a danger of explosion if battery is incorrectly replaced. Replace only with same or equivalent type recommended by the manufacturer. Discard used batteries according to manufacturer's instructions.*



Caution! *There is a danger of a new battery exploding if it is incorrectly installed. Do not attempt to recharge, force open, or heat the battery. Replace the battery only with the same or equivalent type recommended by the manufacturer. Discard used batteries according to the manufacturer's instructions.*



1.8 Jumper Settings

This section provides instructions on how to configure your motherboard by setting the jumpers. It also includes the motherboards's default settings and your options for each jumper.



1.8.1 How to Set Jumpers

You can configure your motherboard to match the needs of your application by setting the jumpers. A jumper is a metal bridge that closes an electrical circuit. It consists of two metal pins and a small metal clip (often protected by a plastic cover) that slides over the pins to connect them. To “close” (or turn ON) a jumper, you connect the pins with the clip. To “open” (or turn OFF) a jumper, you remove the clip. Sometimes a jumper consists of a set of three pins, labeled 1, 2, and 3. In this case you connect either pins 1 and 2, or 2 and 3. A pair of needle-nose pliers may be useful when setting jumpers.

1.8.2 CMOS Clear (CMOS1)

The AIMB-582 motherboard contains a jumper that can erase CMOS data and reset the system BIOS information. Normally this jumper should be set with pins 1-2 closed. If you want to reset the CMOS data, set CMOS1 to 2-3 closed for just a few seconds, and then move the jumper back to 1-2 closed. This procedure will reset the CMOS to its default setting.

Table 1.3: CMOS1

Function	Jumper Setting
*Keep CMOS data	 1-2 closed
Clear CMOS data	 2-3 closed

* Default

1.8.3 JLVD1-2: LCD Power 3.3 V/ 5 V/ 12 V Selector

Table 1.4: JLVD1-2: LCD Power 3.3 V/5 V/ 12 V Selector

Closed Pins	Result
JLVD1, 1-2	Jumper for +3.3 V
JLVD1, 2-3	Jumper for +5V
JLVD1, 2 JLVD2, 2	Jumper for +12 V

*Default

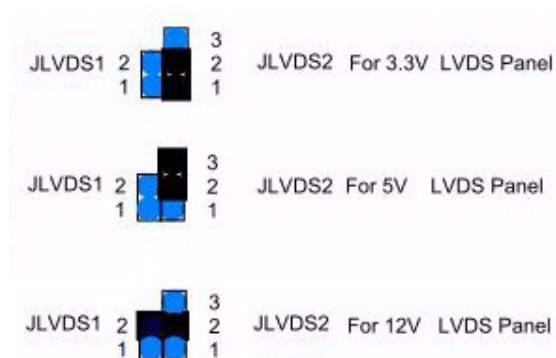

1.8.4 JUSBPWR1-4 (USB Power Selection Connector)

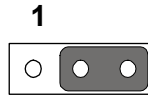

Default: 2-3 Pin (+5 V)

Table 1.5: JUSBPWR1-4 (USB Power Selection Connector)

Pin	Pin Name
1	+V5_DUAL
2	+V5_USB
3	+V5

1.8.5 PSON1: ATX, AT Mode Selector

Table 1.6: PSON1: ATX, AT Mode Selector

Closed Pins	Result
1-2	AT Mode
2-3*	ATX Mode

*Default

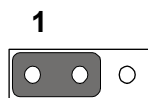

AT Mode
1-2 closed

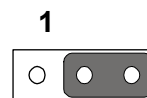

ATX Mode
2-3 closed

1.8.6 JIR1+JOB1+JWD1: Watchdog Timer Output and OBS Alarm Option

Table 1.7: JIR1+JOB1+JWD1: Watchdog Timer Output and OBS Alarm Option

Pin	Pin Name
1	+V5
2	NC
3	NC
4	SIO_WG#
5	SIO_IRRX
6	SRST#
7	GND
8	ERR_BEEP
9	SIO_IRTX
10	OBS_BEEP

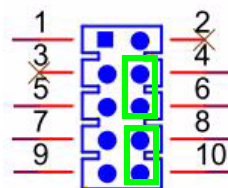

1.8.7 JME1:BIOS Update ME Mode Selector

JME1 is the jumper for users to select BIOS update freely without lock protection when using ADVSPI or with lock protection.

Table 1.8: BIOS update ME mode selector

Function	Jumper Setting	BIOS protect	Master Region Access Control	Update tool	ME version	ME function after update	Setting	JME1 PWR working status
1.*Production mode	(1-2) pin closed	None	FF	ADVSPI	updated	Link/remote control	default	AC on/ stdby
2.		Lock Read:0B Write:0A	ADVSPI	no updated	Link/remote control	OEM request	AC on/ stdby	
3. Manufacture mode	(2-3) pin closed	None	FF	ADVSPI	updated	None	None	None

* refers to default.

- * In default production mode, there's no lock protection for BIOS. The Master Region Access Control setting is FF, users can update the complete BIOS with the ADVSPI tool. The function is same as Manufacture mode. BIOS ME (Management Engine) function keeps link/remote control. The jumper can be set under AC off PWR status, it can not be set under standby PWR status.
- In production mode with lock protection for BIOS, the Master Region Access Control setting is Read:0B, Write:0A. Users can not update BIOS ME firmware freely. BIOS ME (Management Engine) function keeps link/remote control. This setting is only for OEM project requests. The jumper can be set under AC off PWR status, it can not set under standby PWR status.
- In manufacture mode, BIOS has no lock protection function. The Master Region Access Control setting is FF, users can update complete BIOS with ADVSPI tool. However, the BIOS ME function does not keep the link/remote control after the BIOS been updated.

1.8.8 JCASE1: Case Open Sensor

The AIMB-582 motherboard contains a jumper that provides a chassis open sensor. The buzzer on the motherboard beeps when the case is opened.

1.9 System Memory

AIMB-582 has four 240-pin memory sockets for 1333/1600 MHz memory modules with maximum capacity of 32 GB (Maximum 8 GB for each DIMM). AIMB-582QG2 supports only non-ECC DDR3 memory modules and do not support registered DIMMs (RDIMMs)

Note!  Because AIMB-582 supports Intel Active Management Technology 8.0 (iAMT 8.0) which utilizes some memory space of channel 0, it's suggested that the user should not leave channel 0 DIMM slots (DIMMA1 and DIMMA2) empty, or it may cause some system abnormality.

1.10 Memory Installation Procedures

To install DIMMs, first make sure the two handles of the DIMM socket are in the “open” position, i.e., the handles lean outward. Slowly slide the DIMM module along the plastic guides on both ends of the socket. Then firmly but gently (avoid pushing down too hard) press the DIMM module well down into the socket, until you hear a click when the two handles have automatically locked the memory module into the correct position of the DIMM socket. To remove the memory module, just push both handles outward, and the memory module will be ejected by the mechanism.

1.11 Cache Memory

The AIMB-582 supports a CPU with one of the following built-in full speed L3 caches:

8MB for Intel Xeon E3 1275v2

8MB for Intel Xeon E3 1275

8MB for Intel Xeon E3 1225v2

6MB for Intel Xeon E3 1225

8MB for Intel Core i7 3770

8MB for Intel Core i7 2600

6MB for Intel Core i5 3550S

6MB for Intel Core i5 2400

3MB for Intel Core i3 3220

3MB for Intel Core 3120

3MB for Intel Pentium G850

2MB for Intel Celeron G540

The built-in second-level cache in the processor yields much higher performance than conventional external cache memories.

1.12 Processor Installation

The AIMB-582 is designed for LGA1155, Intel Xeon and Intel Core i7/Core i5/Core i3/ Pentium/Celeron processor.

1.13 PCI Bus Routing Table

AD PCI slot INT	PCI1	PCI2
	AD16	AD21
A	A	F
B	B	G
C	C	H
D	D	E

Chapter 2

Connecting
Peripherals

2.1 Introduction

You can access most of the connectors from the top of the board as it is being installed in the chassis. If you have a number of cards installed or have a packed chassis, you may need to partially remove the card to make all the connections.

2.2 USB Ports (LAN1_USB01/LAN2_USB23/USB45/USB89/USB1011/USB1213)

The AIMB-582 provides up to 12 USB ports. The USB interface complies with USB Specification Rev 2.0 supporting transmission rates up to 480 Mbps and Rev 3.0 supporting transmission rate up to 5 Gbps and is fuse protected. The USB interface can be disabled in the system BIOS setup.

The AIMB-582 is equipped with two high-performance 1000 Mbps Ethernet LAN adapters, both of which are supported by all major network operating systems. The RJ-45 jacks on the rear panel provides convenient LAN connection.

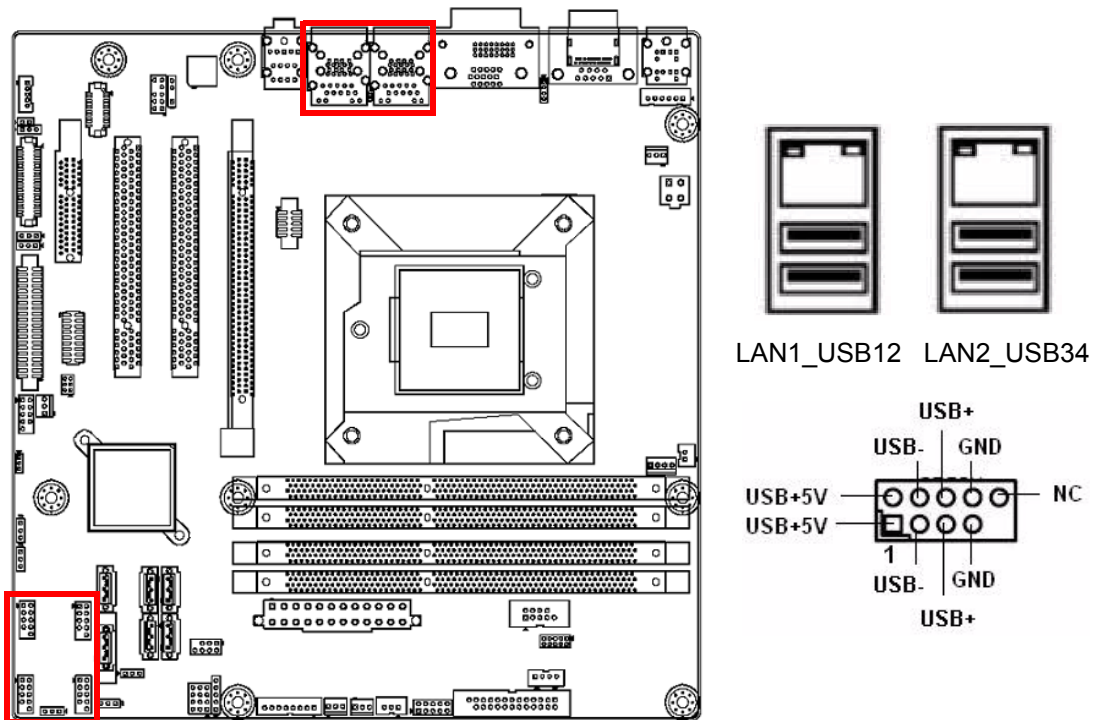
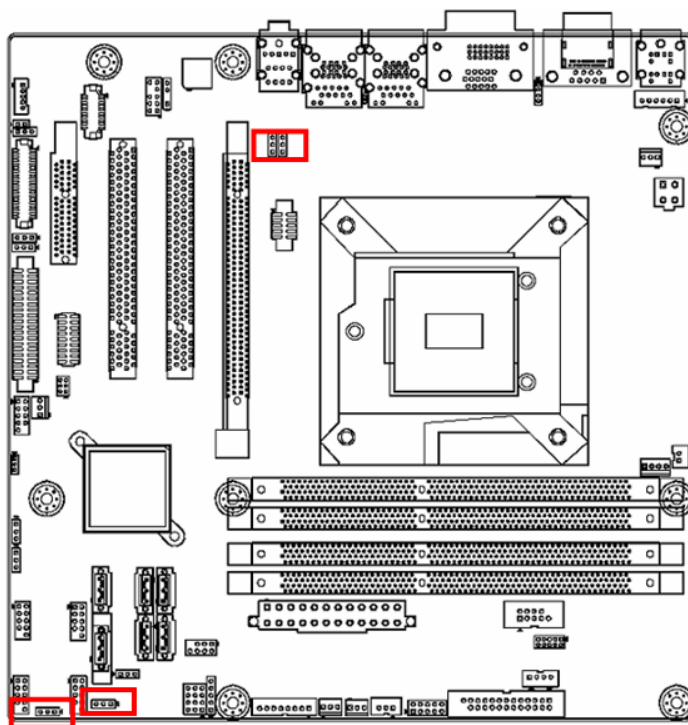

Table 2.1: LAN LED Indicator

LAN Mode	LAN Indicator	
LAN1 indicator	LED1 (Right)	off for mal-link; Link (On) / Active (Flash)
	LED2 (Left)	100 Mbps (On) / 10 Mbps (Off)
	LED2 (Left)	1000 Mbps (On)
LAN2 indicator	LED1 (Right)	off for mal-link; Link (On) / Active (Flash)
	LED2 (Left)	100 Mbps (On) / 10 Mbps (Off)
	LED2 (Left)	1000 Mbps (On)

2.3 USB Power Switch

AIMB-582 allows users to set USB power between +5 VSB and +5 V. When the jumper is set as +5 V (default 2-3 pin), the board doesn't support wake from S3 via keyboard or mouse. If need to set as +5 Vsb, need to modify the jumper (1-2 pin) and ask for to modify the customized BIOS at the same time.



Jumper	USB Ports
JUSBPWR1	USB port 1~4
JUSBPWR2	USB port 5/6/7/8/11/12



1-2* pin is default

Note! When USB power is switched to +5V, it can't be connected with power KVM.



2.4 VGA/DVI-D Connector (VGA1+DVI 1) Connector

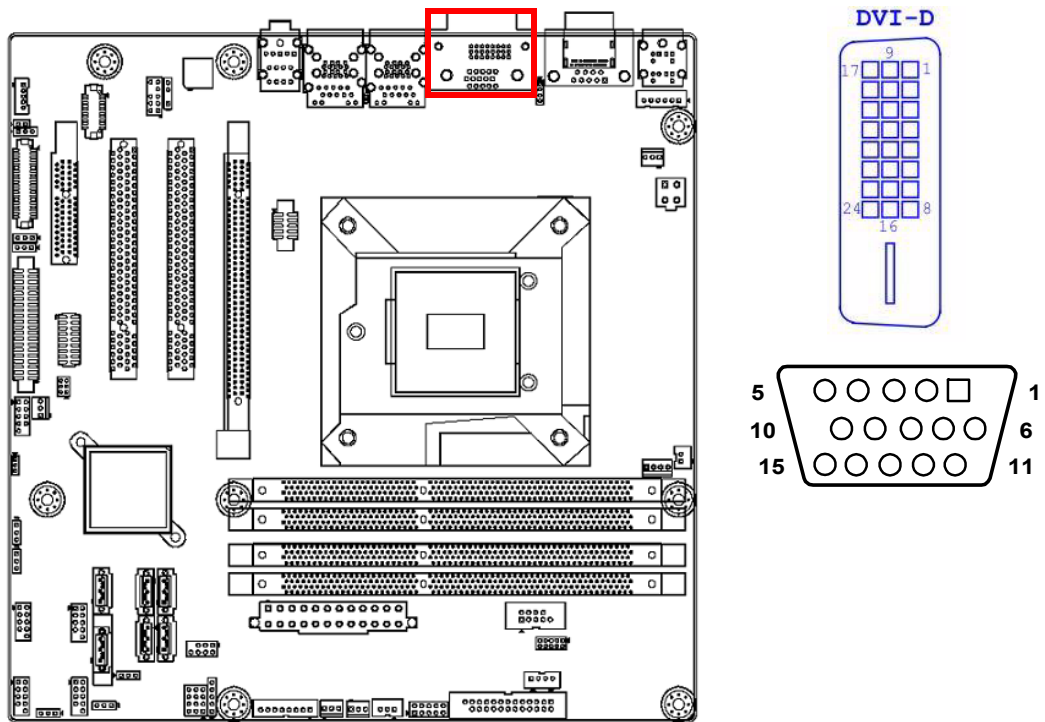

AIMB-582 includes VGA and DVI interfaces that can drive conventional VGA and DVI displays. VGA is a standard 15-pin D-SUB connector commonly used for VGA. Pin assignments for VGA and DVI connectors are detailed in Appendix B.

2.5 Serial Ports (COM1~COM6)

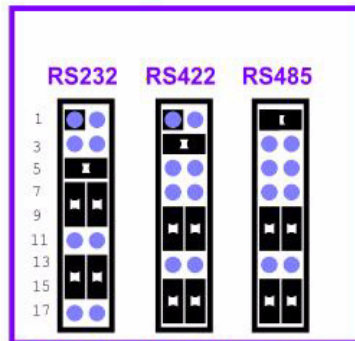
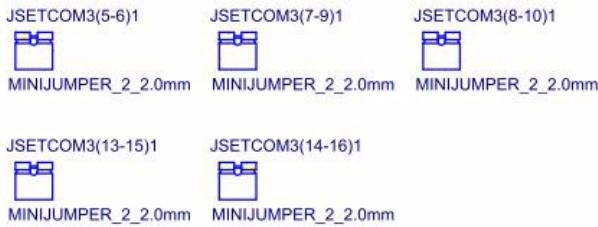
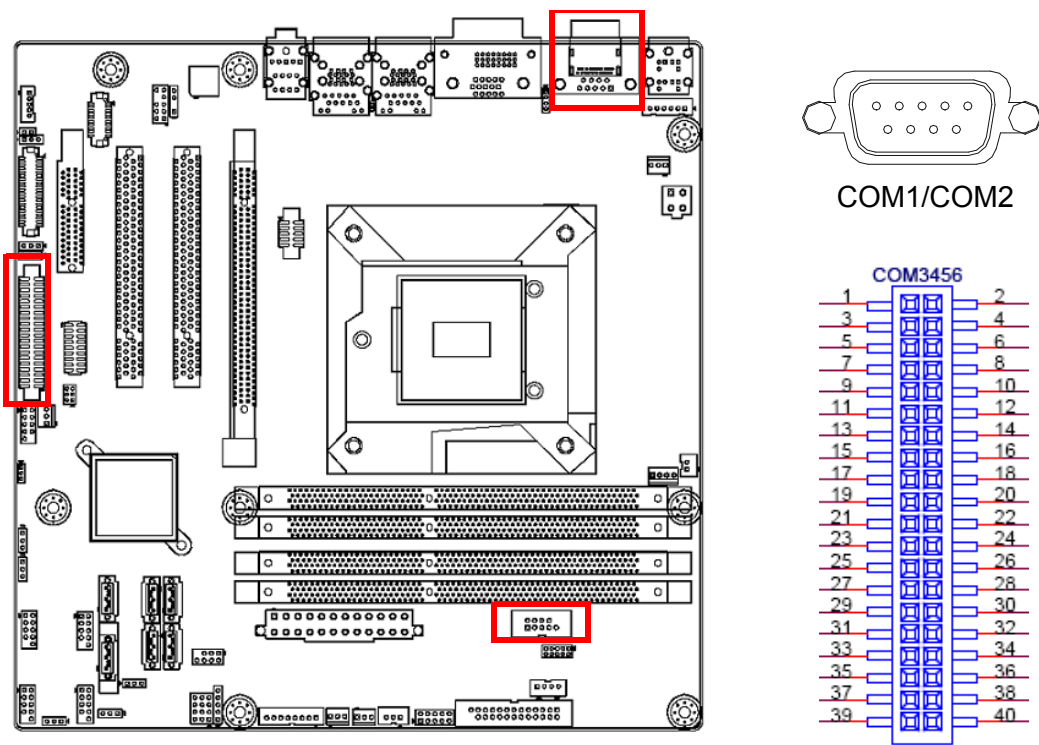

COM3 RS232/422/485 Jumper setting

AIMB-582 supports six serial ports. COM1, COM2, COM4-6 supports RS-232. COM3 supports RS-232/422/485 (with 5V/12V power). JSETCOM3 is used to select the RS-232/422/485 mode for COM3.

These ports can connect to serial devices, such as a mouse or a printer, or to a communications network.

The IRQ and address ranges for both ports are fixed. However, if you want to disable the port or change these parameters later, you can do this in the system BIOS setup.

Different devices implement the RS-232 standards in different ways. If you have problems with a serial device, be sure to check the pin assignments for the connector.

2.6 Display Port (DP1)

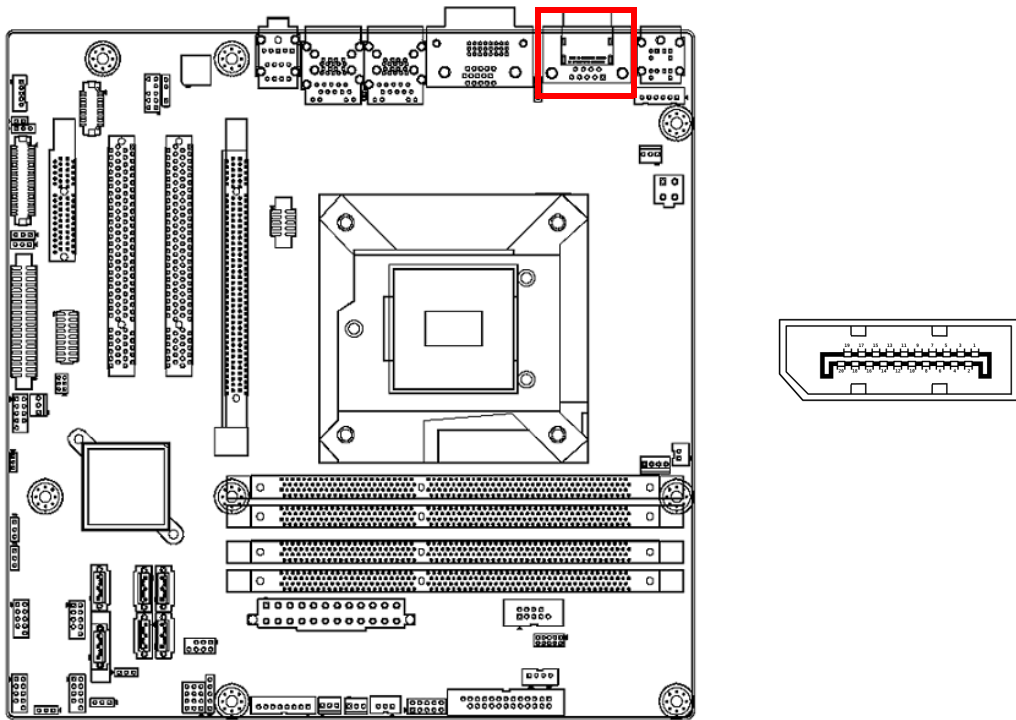

AIMB-582 has one external DP connector to supports the Display Port panel.

2.7 PS/2 Keyboard and Mouse Connector (KBMS1)/ External PS/2 Keyboard and Mouse Connector (KBMS2)

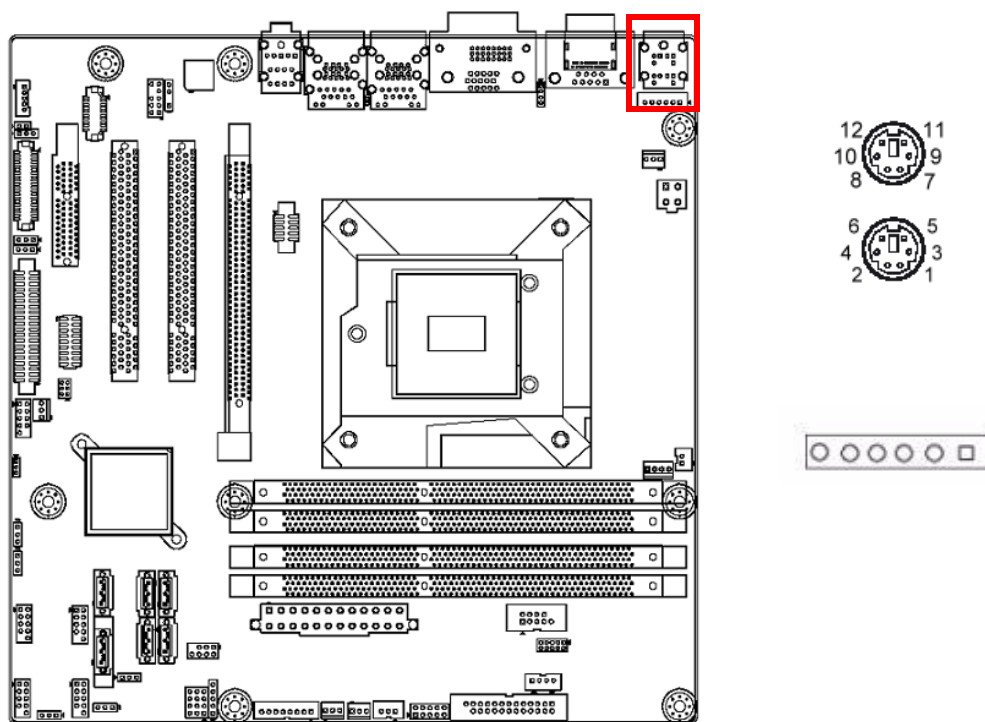

Two 6-pin mini-DIN connectors (KBMS1) on the motherboard provide connection to a PS/2 keyboard and a PS/2 mouse, respectively. KBMS2 is for supporting the 2nd PS/2 keyboard and PS/2 mouse by a cable P/N 1700018699.

2.8 CPU Fan Connector (CPU_FAN1)

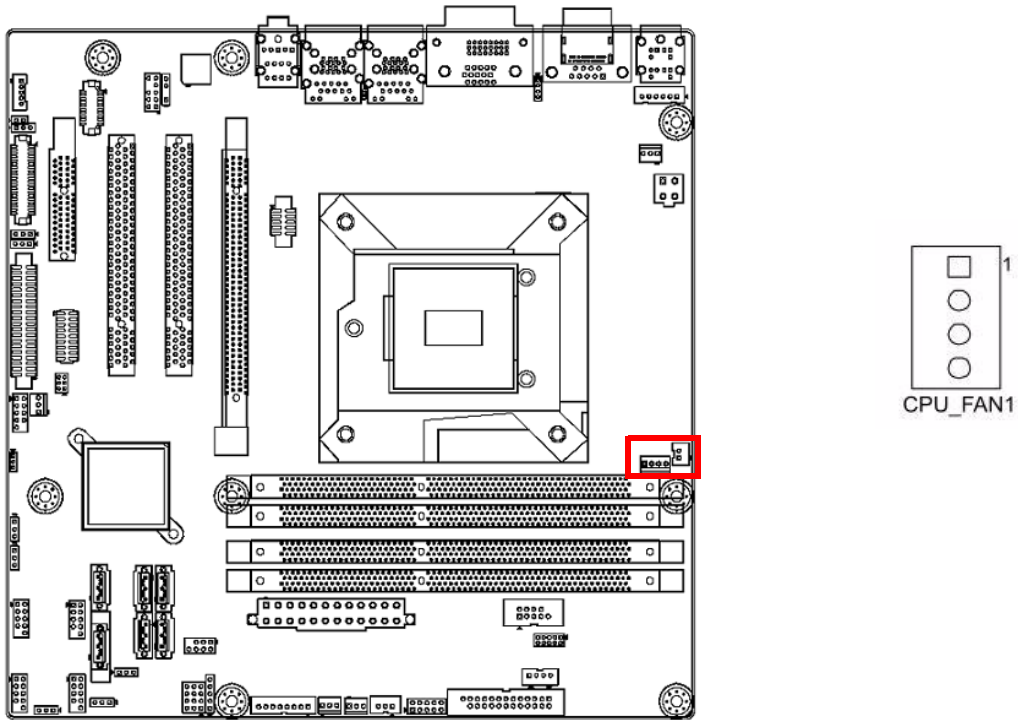

If a fan is used, this connector supports cooling fans of 500 mA (6 W) or less.

2.9 System FAN Connector (SYSFAN1/2/3/4)

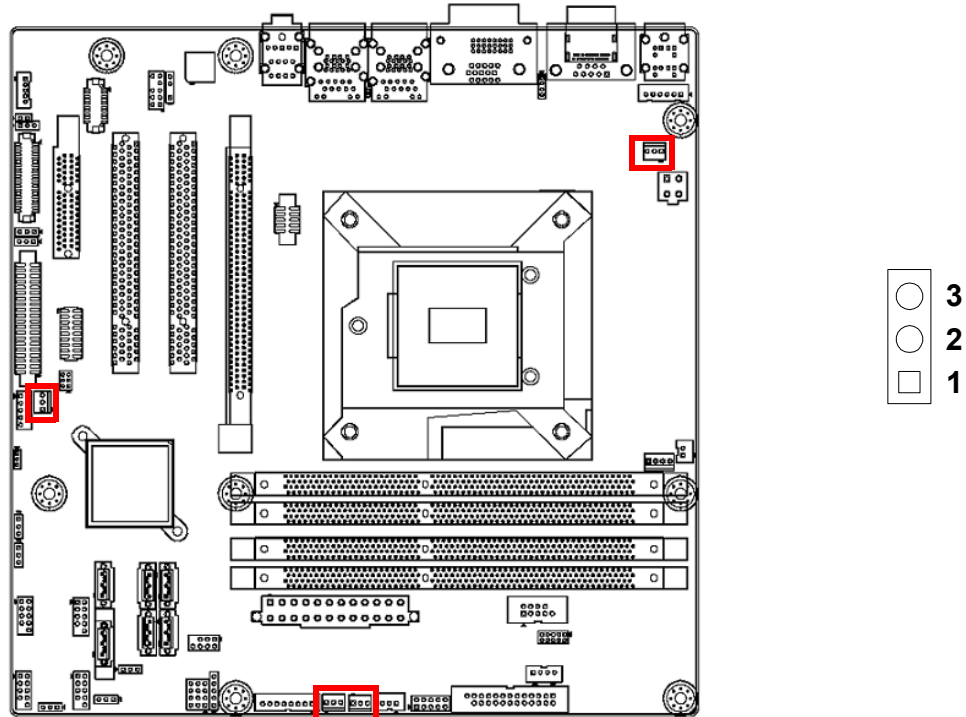

If a fan is used, this connector supports cooling fans of 500 mA (6 W) or less.

2.10 Front Panel Connectors (JFP1/JFP2/JFP3)

There are several headers for monitoring and controlling the AIMB-582.

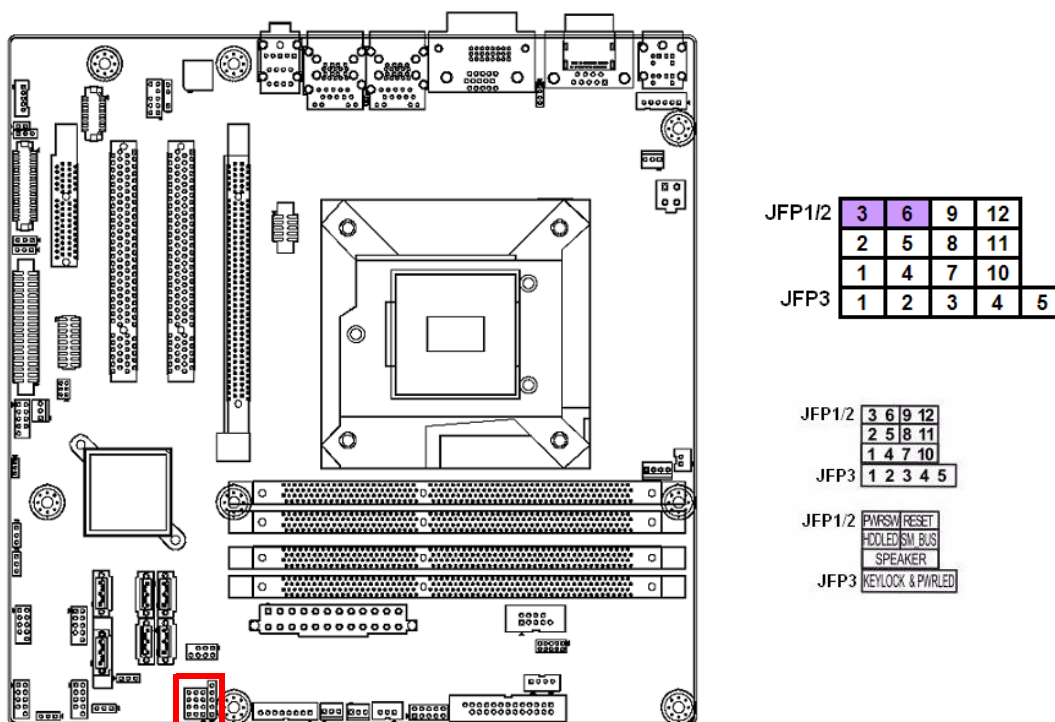

2.10.1 ATX soft power switch ((JFP1/PWR_SW))

If your computer case is equipped with an ATX power supply, you should connect the power on/off button on your computer case to ((JFP1/ PWR_SW)), for convenient power on and off.

2.10.2 Reset (JFP1/RESET)

Many computer cases offer the convenience of a reset button. Connect the wire for the reset button.

2.10.3 HDD LED (JFP1/HDDLED)

You can connect an LED to connector (JFP2/HDDLED) to indicate when the HDD is active.

2.10.4 External speaker (JFP1/SPEAKER)

JFP1/SPEAKER is a 4-pin connector for an external speaker. If there is no external speaker, the AIMB-582 provides an onboard buzzer as an alternative. To enable the buzzer, set pins 7 & 10 as closed.

2.10.5 Power LED and keyboard lock connector (JFP3/PWR_LED & KEY LOCK)

(JFP3/PWR_LED & KEY LOCK) is a 5-pin connector for the power on LED and Key Lock function. Refer to Appendix B for detailed information on the pin assignments. The Power LED cable should be connected to pin 1-3. The key lock button cable should be connected to pin 4-5. There are 3 modes for the power supply connection. The first is “ATX power mode”; the system turns on/off by a momentary power button. The second is “AT Power Mode”; the system turns on/off via the power supply switch. The third is another “AT Power Mode” which makes use of the front panel power switch. The power LED status is indicated in the following table:

Table 2.2: ATX power supply LED status (No support for AT power)

Power mode	LED (ATX Power Mode) (On/off by momentary button)	LED (AT power Mode) (On/off by switching power supply)	LED (AT power Mode) (On/off by front panel switch)
PSON1 (on back plane) jumper setting	pins 2-3 closed	pins 1-2 closed	Connect pins 1 & 2 to panel switch via cable
System On	On	On	On
System Suspend	Fast flashes	Fast flashes	Fast flashes
System Off	Slow flashes	Off	Off

2.11 Line Out, Mic In Connector (AUDIO1)

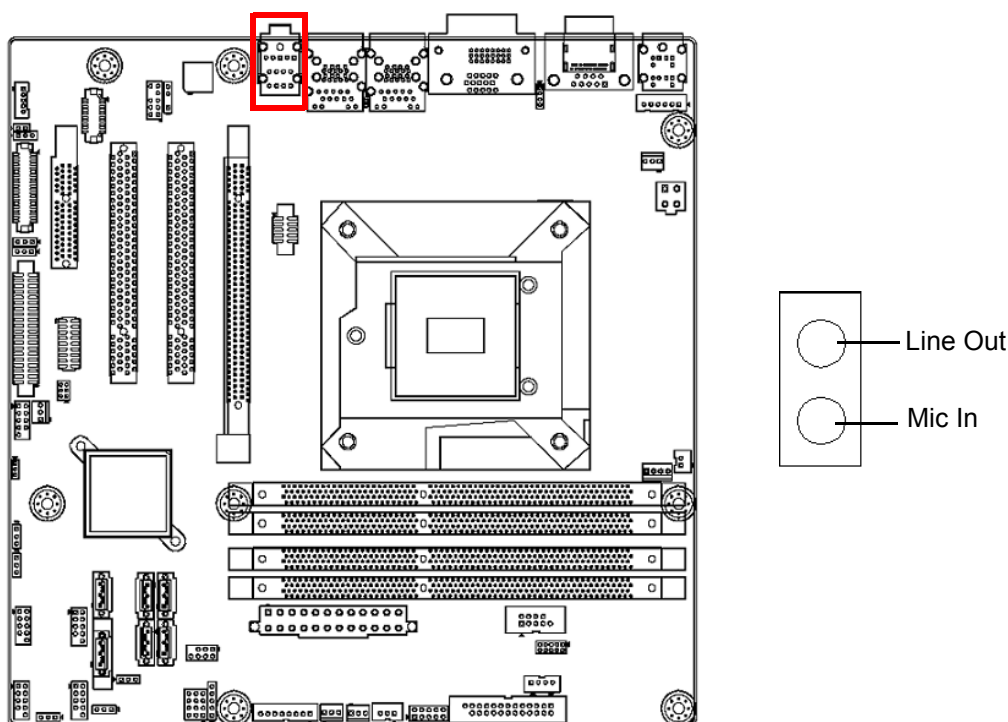

2.12 Digital Audio Connector (SPDIF_OUT1)

This connector is for the S/PDIF audio module to allow digital output sound. Connect one end of the S/PDIF audio cable to this connector and the other end to the S/PDIF module.

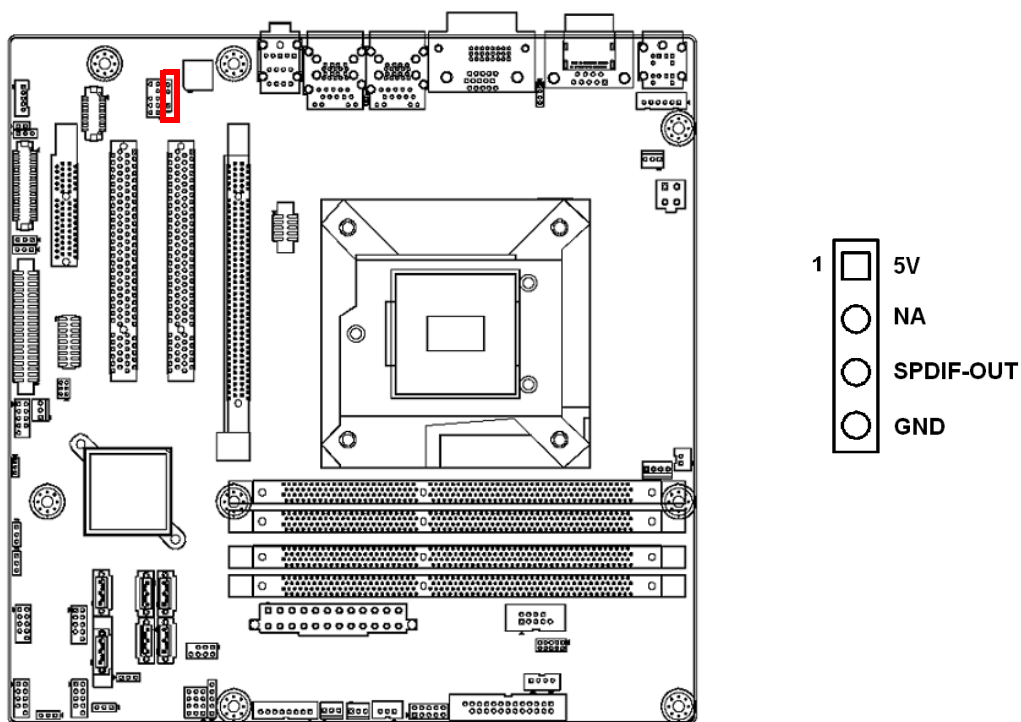

Note! The S/PDIF module is purchased separately.



2.13 Serial ATA Interface (SATA1 ~ SATA6)

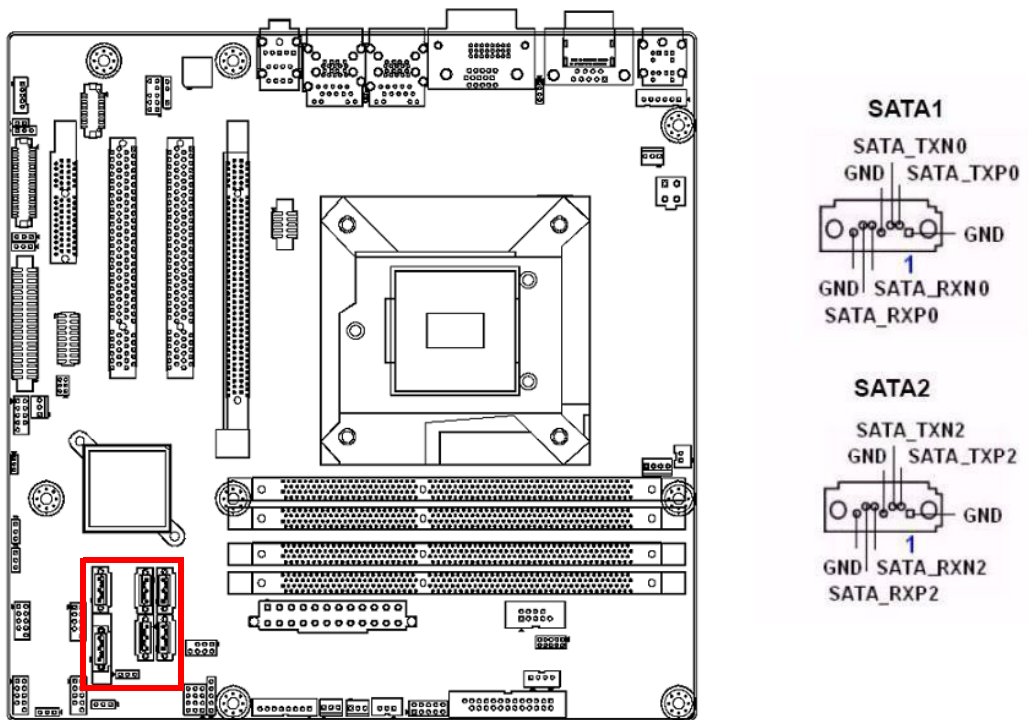

AIMB-582 features a high performance Serial ATA interface (up to 300 MB/s) and Serial ATA III interface (up to 600 MB/s) which eases hard drive cabling with thin, space-saving cables.

Note! *AIMB-582 on board SATA only supports Fedora 14 and 15 and SATA mode in BIOS should be set as AHCI mode.*

 *If SATA mode is set as IDE mode, when user is installing Fedora 14 and 15, ODD has been connected on SATA port 3~6.*

2.14 8-pin Alarm Board Connector (VOLT1)

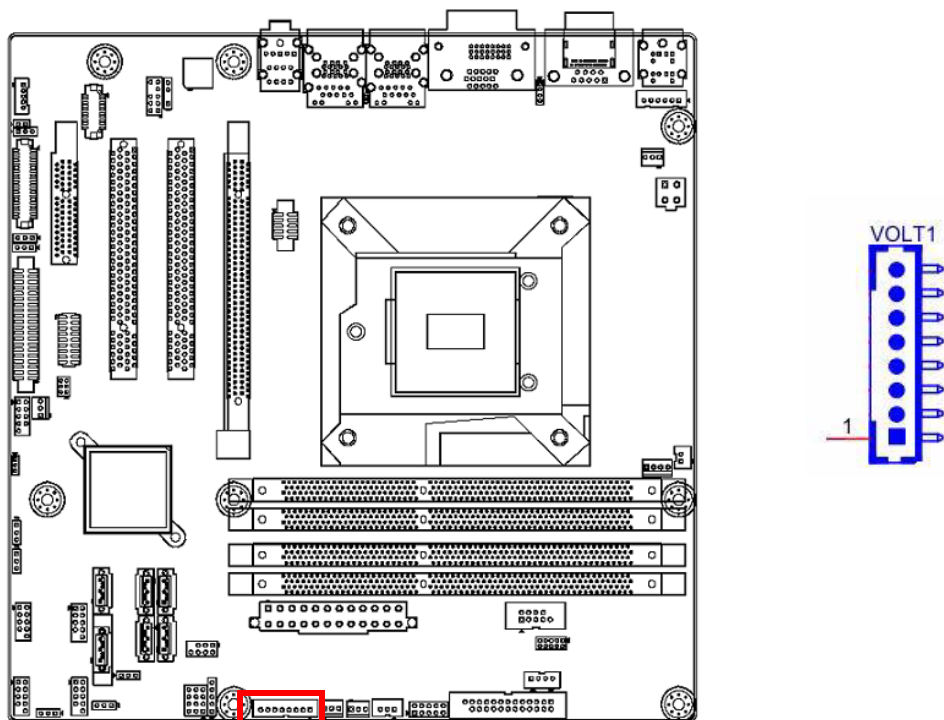

VOLT1 connects to the alarm board on the chassis. These alarm boards give warnings if a power supply or fan fails, or if the chassis overheats.

2.15 PCI express x16 slot

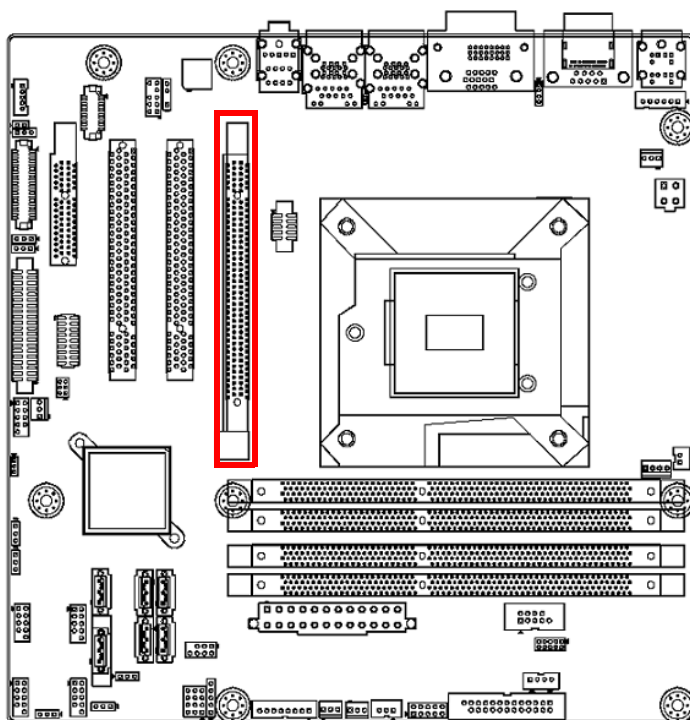

AIMB-582 provides a PCIe x16 slot for users to install add-on cards when their applications require higher graphic performance than the CPU embedded graphics controller can provide.

2.16 Front Panel Audio Connector (FPAUD1)

This connector is for a chassis-mounted front panel audio I/O module that supports either HD Audio or legacy AC'97 (optional) audio standard. Connect this connector with the front panel audio I/O module cable.

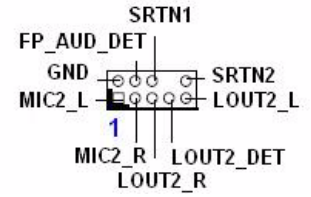
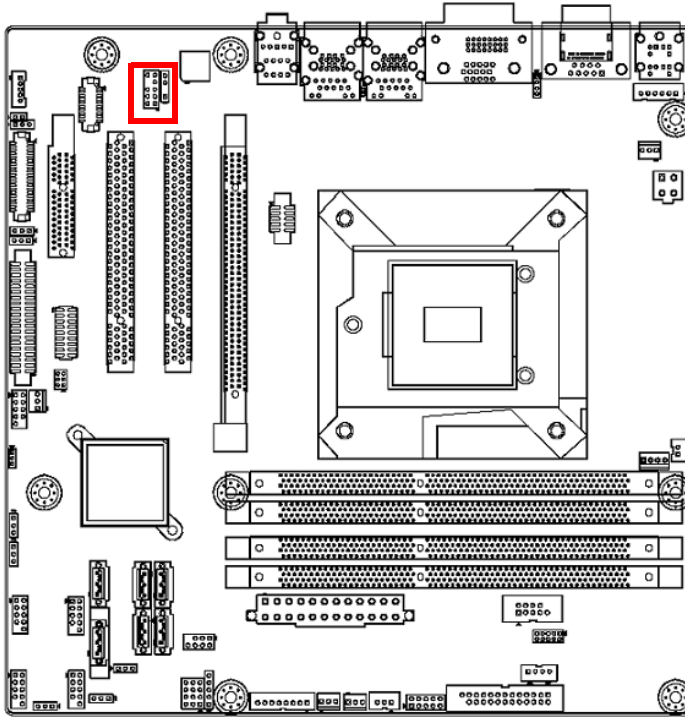

Note!  For motherboards with the optional HD Audio feature, we recommend that you connect a high-definition front panel audio module to this connector to take advantage of the motherboard's high definition audio capability.

2.17 ATX Power Connector (EATXPWR1, ATX12V1)

This connector is for an ATX Micro-Fit power supply. The plugs from the power supply are designed to fit these connectors in only one direction. Determine the proper orientation and push down firmly until the connectors mate completely.

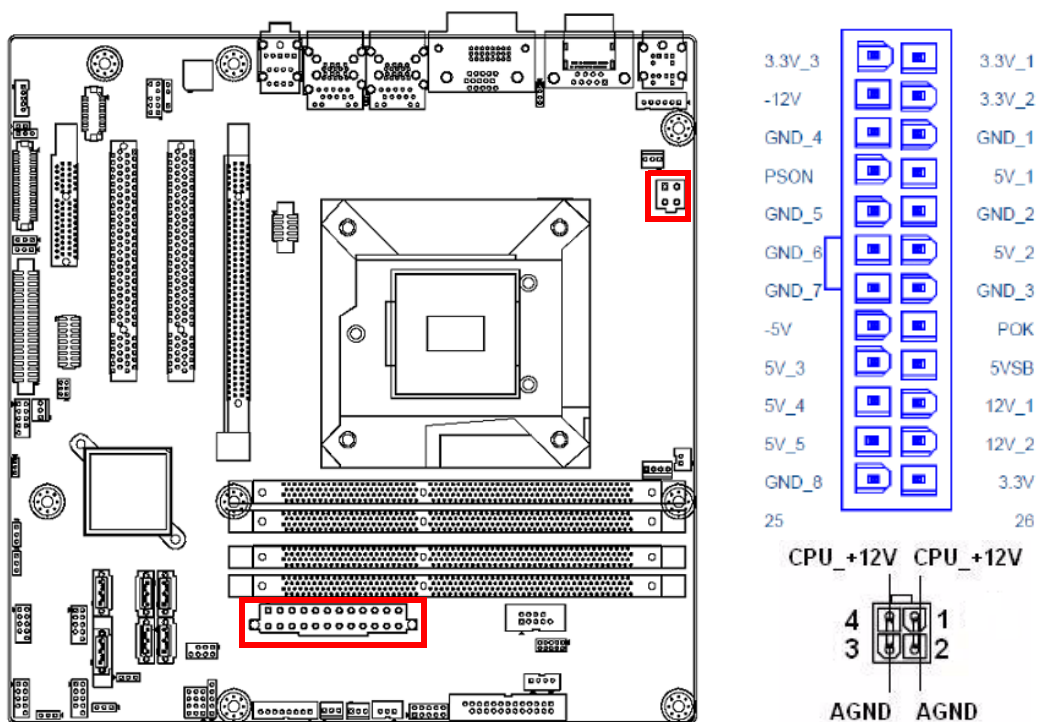

Note!



1. Please connect the ATX12V1 connector with the PSU ATX 12V 4-pin connector.
2. For a fully configured system, we recommend that you use a power supply unit (PSU) that complies with ATX 12 V Specification 2.0 (or later version) and provides a minimum power of 180 W.

2.18 SPI Flash connector(SPI_CN1)

The SPI flash card pin header may be used to flash the BIOS if the AIMB-582 cannot power on.

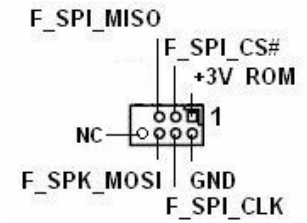
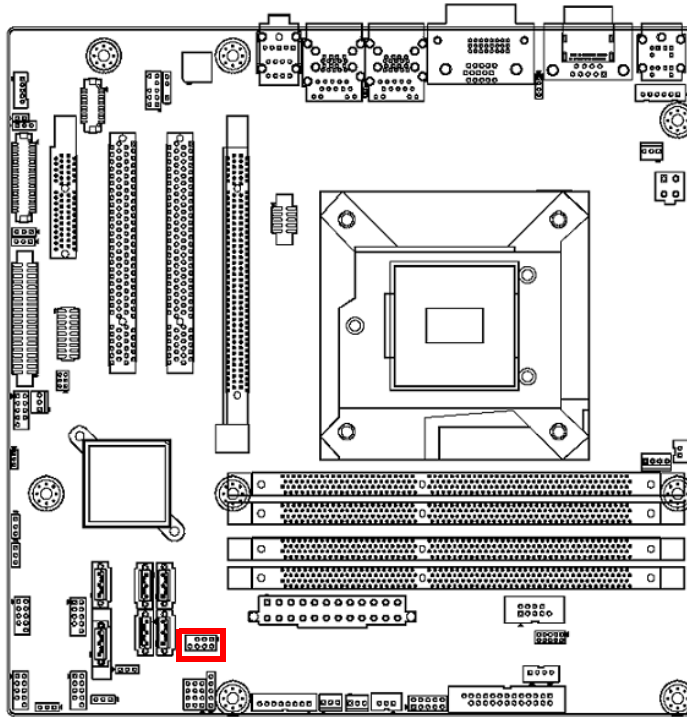

2.19 LVDS Inverter Connector (INV1)

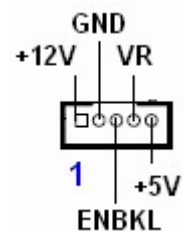
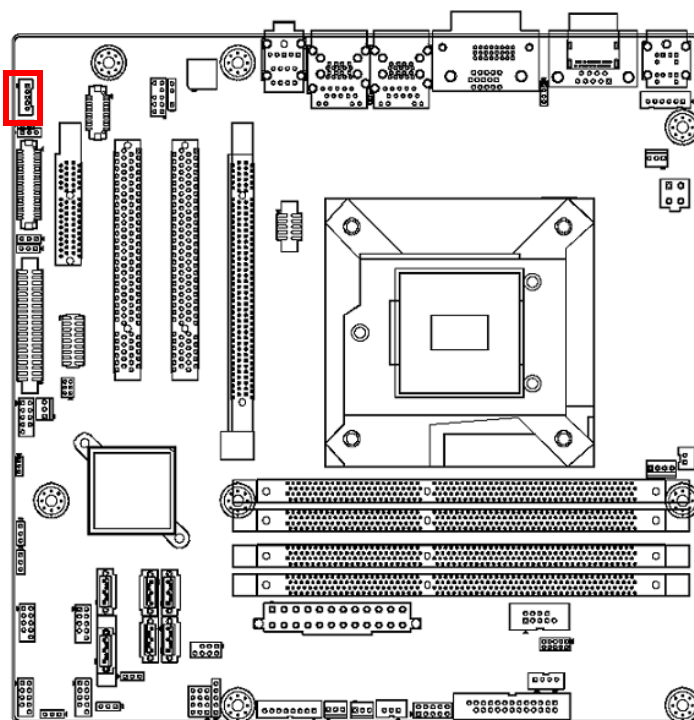

Note!



■ Signal Description

Signal

VR

ENBKL

Signal Description

$V_{adj}=0.75\text{ V}$

(Recommended: $4.7\text{ K}\Omega$, $>1/16\text{ W}$)

LCD backlight ON/OFF control signal

2.20 LVDS Connector (LVDS1)

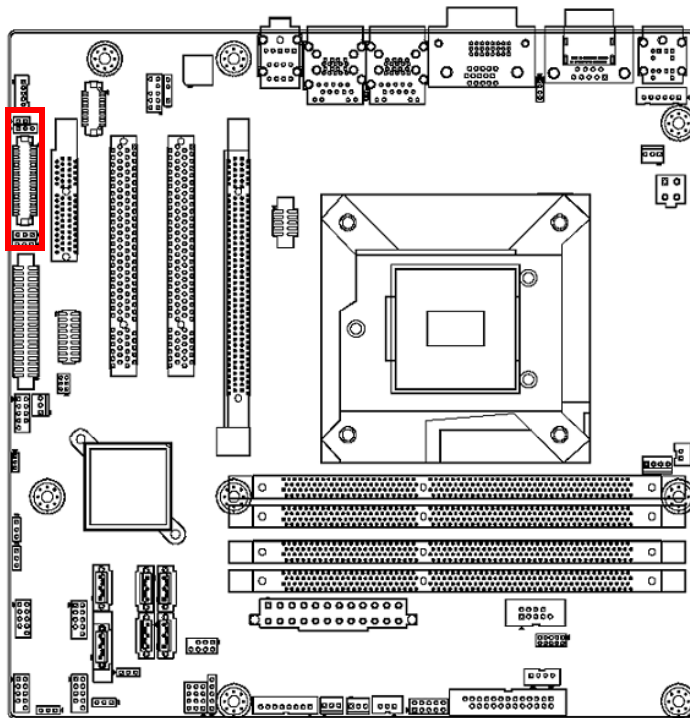

VDDSAFE_1	□	○	VDDSAFE_2
GND_1	○	○	GND_7
VDDSAFE_3	○	○	VDDSAFE_4
OD0-	○	○	ED0-
OD0+	○	○	ED0+
GND_2	○	○	GND_8
OD1-	○	○	ED1-
OD1+	○	○	ED1+
GND_3	○	○	GND_9
OD2-	○	○	ED2-
OD2+	○	○	ED2+
GND_4	○	○	GND_10
OCK-	○	○	ECK-
OCK+	○	○	ECK+
GND_5	○	○	GND_11
DDC_CLK	○	○	DDC_DAT
GND_6	○	○	GND_12
OD3-	○	○	ED3-
OD3+	○	○	ED3+
HPLG	○	○	VCON

2.21 General purpose I/O Connector (GPIO1)

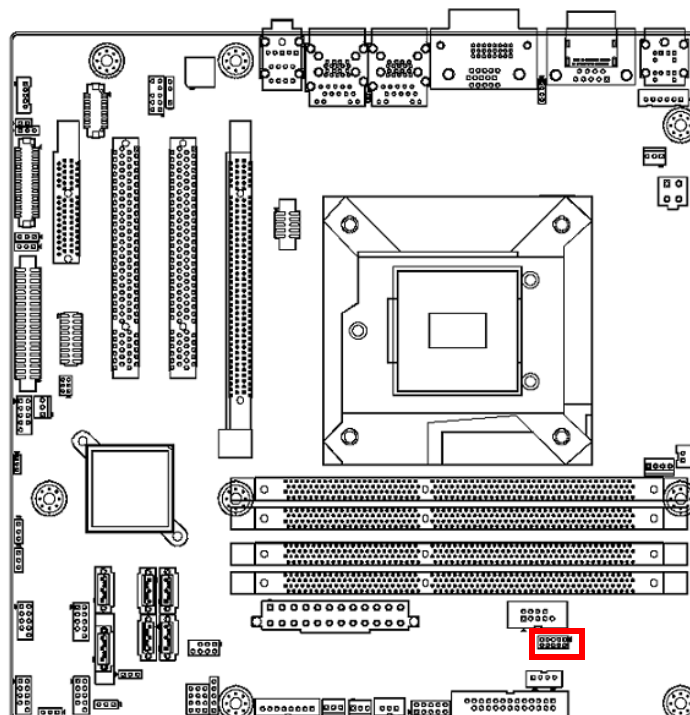

1			
GPIO0	□	□	GPIO4
GPIO1	□	□	GPIO5
GPIO2	□	□	GPIO6
GPIO3	□	□	GPIO7
+5V	□	□	GND

2.22 eDP Connector (eDP1)

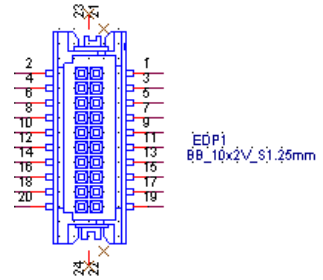
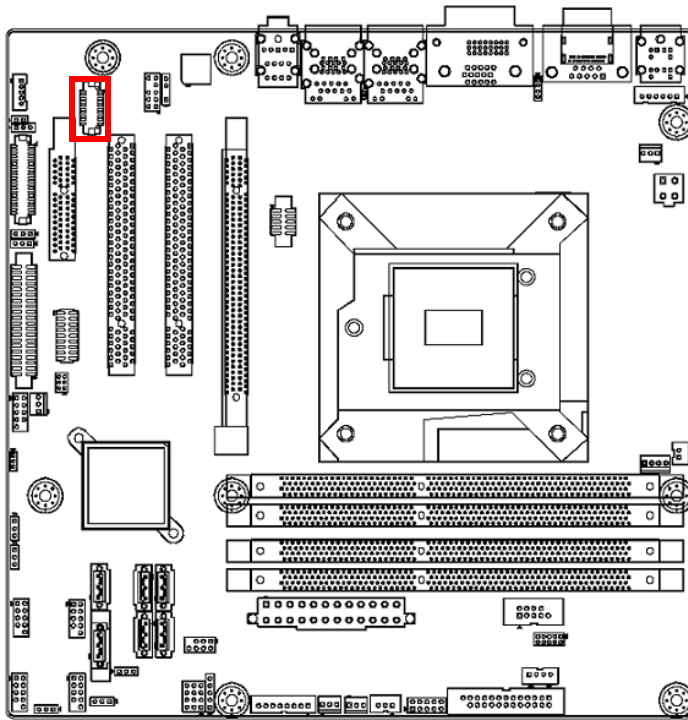

2.23 JTAG Connector (JTAG1)

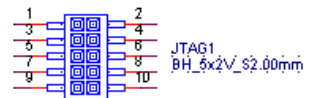
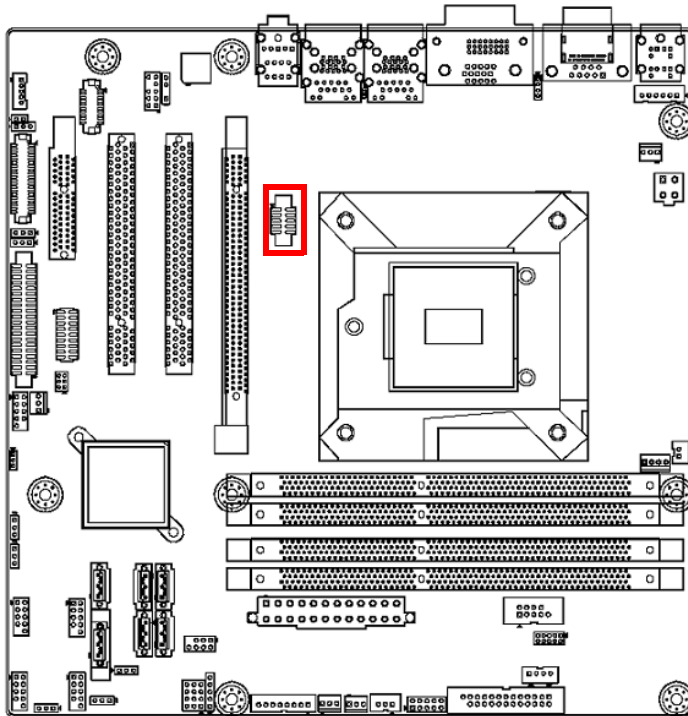

Chapter 3

BIOS Operation

3.1 Introduction

AMI BIOS has been integrated into many motherboards, and has been very popular for over a decade.

With the AMI BIOS Setup program, you can modify BIOS settings to control the special features of your computer. The Setup program uses a number of menus for making changes. This chapter describes the basic navigation of the AIMB-582 setup screens.

3.2 BIOS Setup

The AIMB-582 Series system has AMI BIOS built in, with a SETUP utility that allows users to configure required settings or to activate certain system features.

The SETUP saves the configuration in the FLASH of the motherboard. When the power is turned off, the battery on the board supplies the necessary power to preserve the FLASH.

When the power is turned on, press the button during the BIOS POST (Power-On Self Test) to access the CMOS SETUP screen.

Control Keys

< ← >< → >	Select Screen
< ↑ >< ↓ >	Select Item
<Enter>	Select
<+/->	Change Opt
<F1>	General help
<F2>	Previous Values
<F3>	Optimized Defaults
<F4>	Save & Exit
<Esc>	Exit

3.2.1 Main Menu

Press to enter AMI BIOS CMOS Setup Utility, the Main Menu will appear on the screen. Use arrow keys to select among the items and press <Enter> to accept or enter the sub-menu.

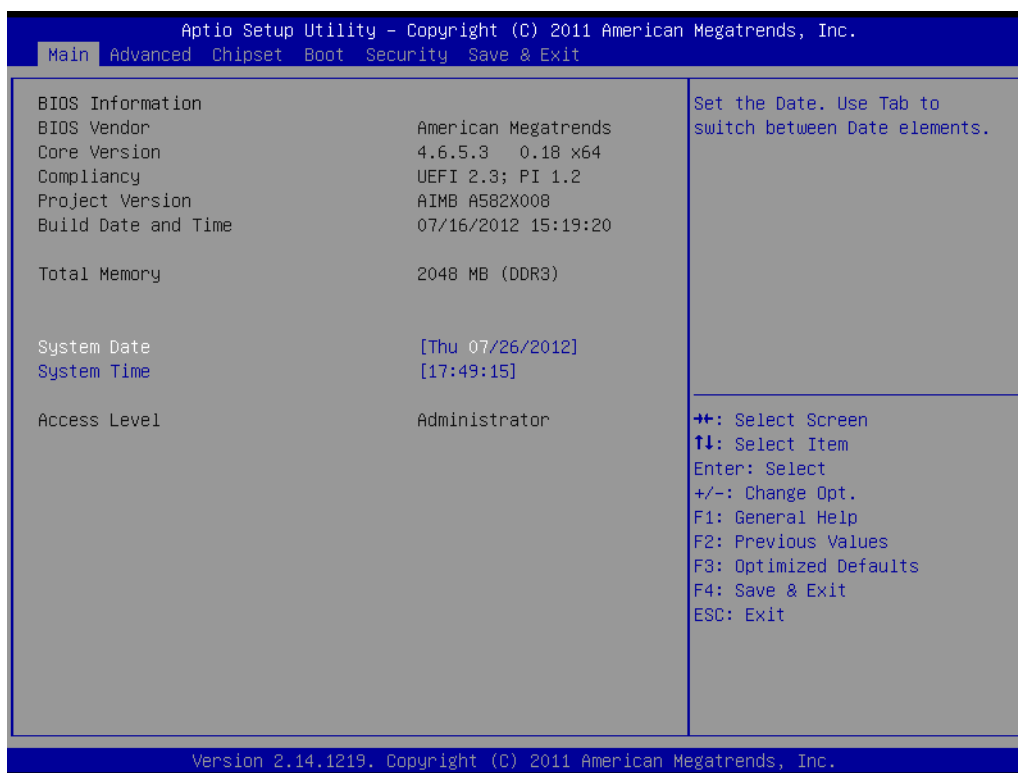

The Main BIOS setup screen has two main frames. The left frame displays all the options that can be configured. Grayed-out options cannot be configured; options in blue can. The right frame displays the key legend.

Above the key legend is an area reserved for a text message. When an option is selected in the left frame, it is highlighted in white. Often a text message will accompany it.

■ System time / System date

Use this option to change the system time and date. Highlight System Time or System Date using the <Arrow> keys. Enter new values through the keyboard. Press the <Tab> key or the <Arrow> keys to move between fields. The date must be entered in MM/DD/YY format. The time must be entered in HH:MM:SS format.

3.2.2 Advanced BIOS Features

Select the Advanced tab from the AIMB-582 setup screen to enter the Advanced BIOS Setup screen. You can select any of the items in the left frame of the screen, such as CPU Configuration, to go to the sub menu for that item. You can display an Advanced BIOS Setup option by highlighting it using the <Arrow> keys. All Advanced BIOS Setup options are described in this section. The Advanced BIOS Setup screen is shown below. The sub menus are described on the following pages.

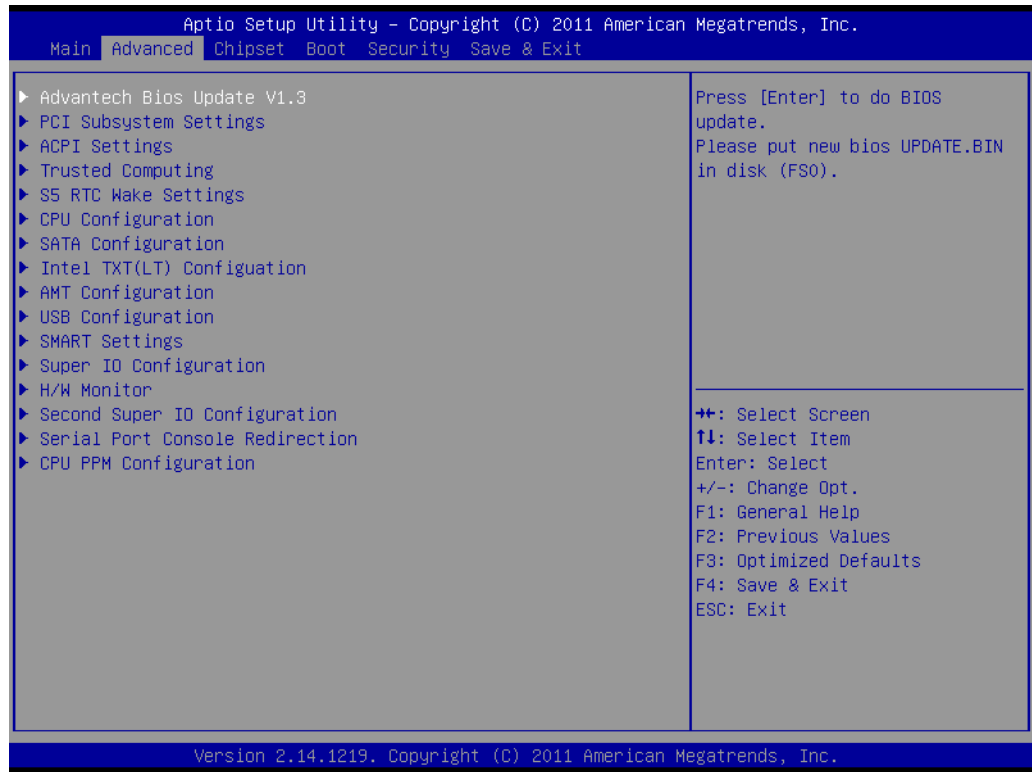

3.2.2.1 PCI Subsystem Settings

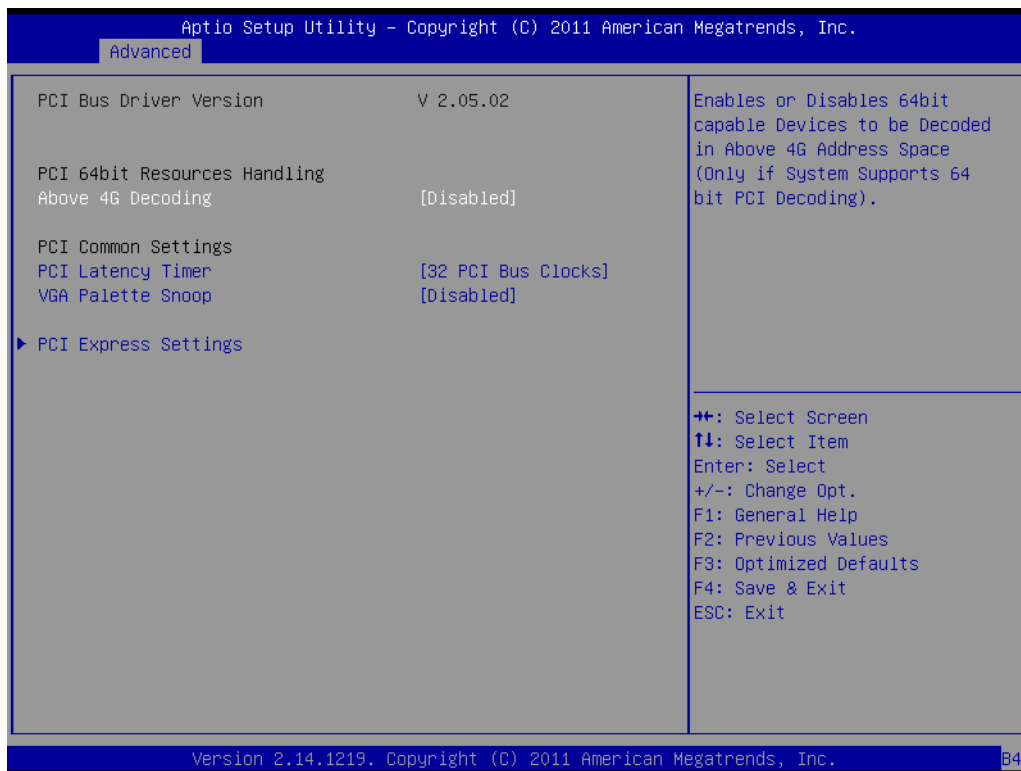

- **Above 4G Decoding [Disabled]**
Enables or disables 64bit capable devices to be decoded on above 4G address space.

Note! Only if system support 64 bit PCI decoding.



3.2.2.2 ACPI Settings

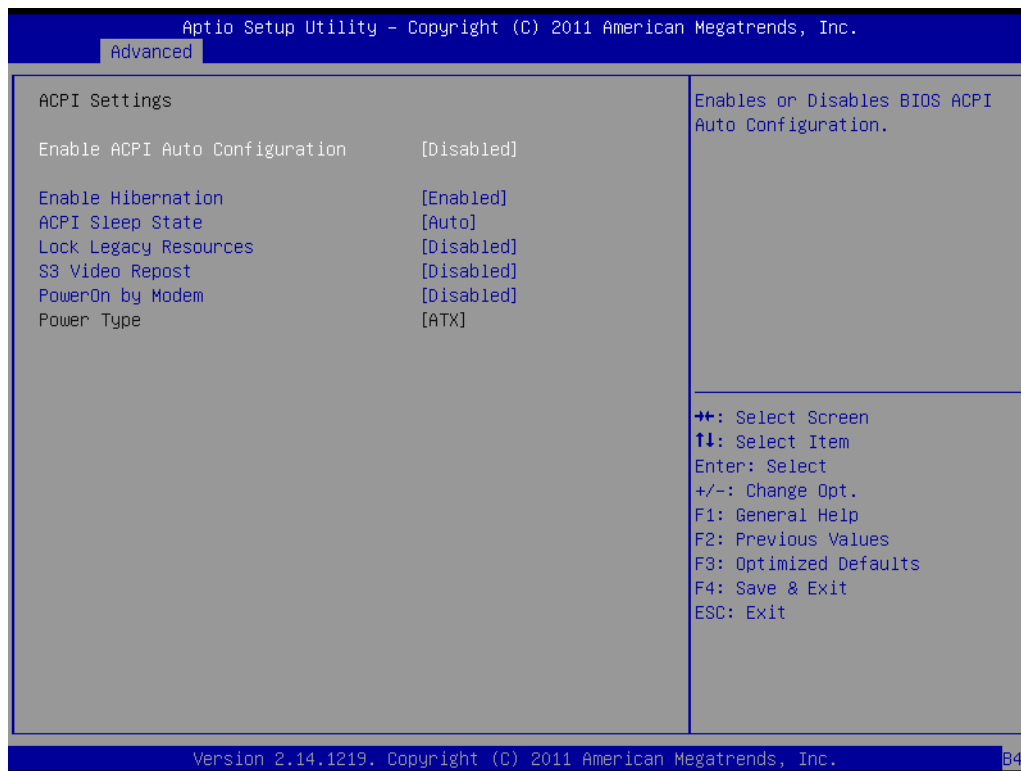

- **Enable ACPI Auto Configuration [Disabled]**
Enable or disable BIOS ACPI auto configuration.
- **Enable Hibernation [Enabled]**
- **ACPI Sleep State [Auto]**
- **Lock Legacy Resources [Disabled]**
- **S3 Video Repost [Disabled]**
- **PowerOn by Modem [Disabled]**
Allows the system to be awakened from an ACPI sleep state by a wake-up signal from a modem that supports wake-up function.
- **Power Type [ATX]**

3.2.2.3 Trusted Computing

To enable/disable TPM (TPM 1.1/1.2) set up in BIOS. TPM (Trusted Platform Module) is a secure key generator and key cache management component, enables protected storage of encryption keys and authentication credentials for enhanced security capabilities.

Note! *The following items function only when a TPM module is installed on board.*

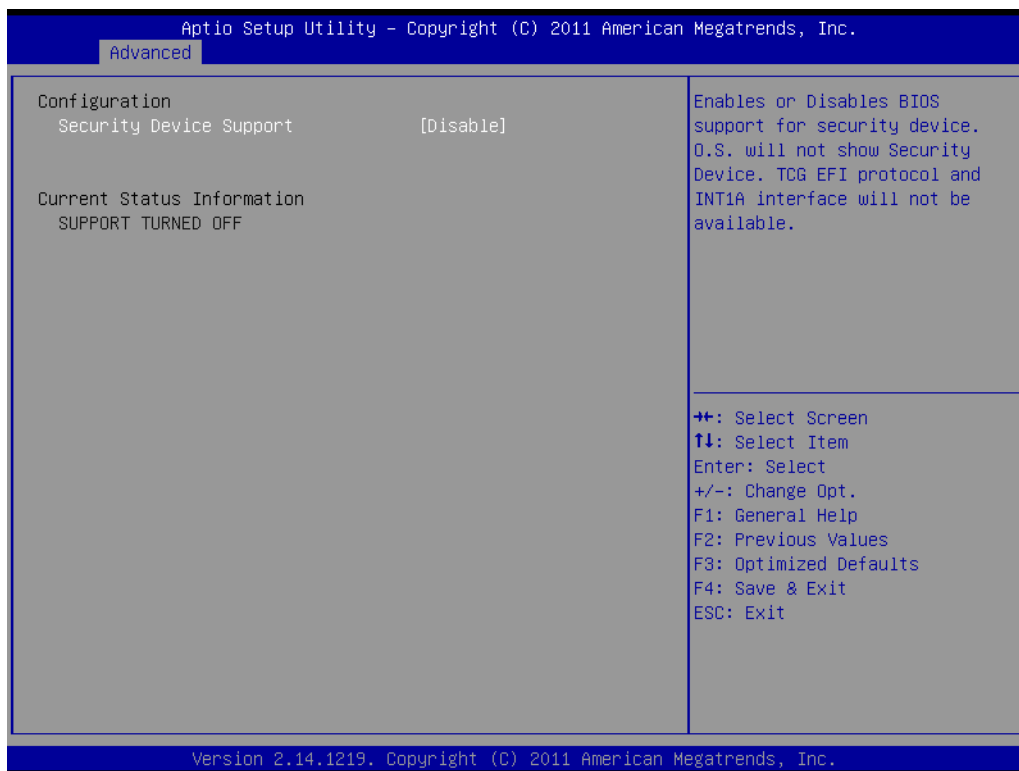

- **Security Device Support [Disable]**

3.2.2.4 S5RTC Wake Settings

The item allow you enable or disable system wake up on alarm event.

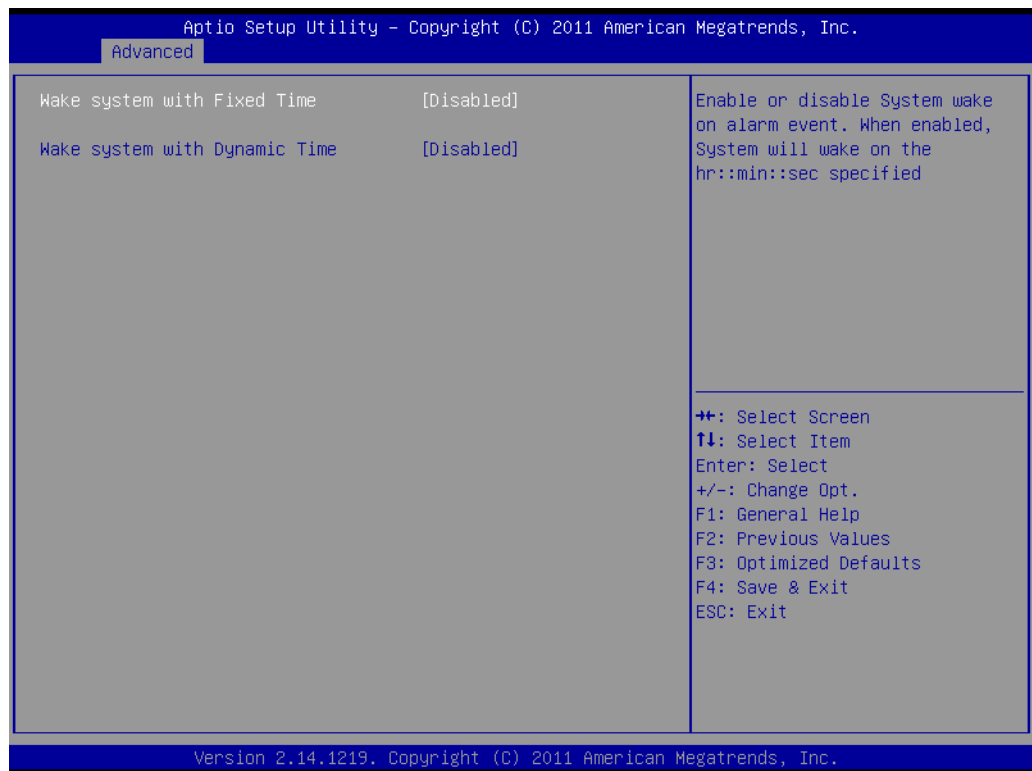

- **Wake system with Fixed Time [Disabled]**
- **Wake system with dynamic Time [Disabled]**

3.2.2.5 CPU Configuration

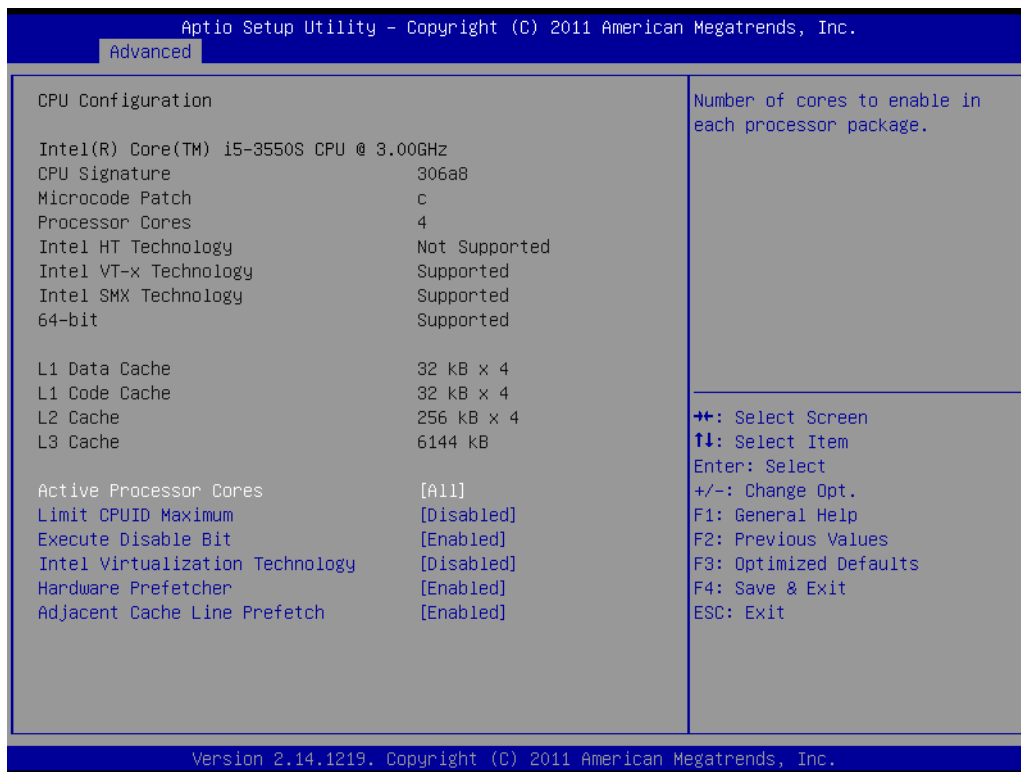

- **Active Processor Cores [All]**
Allows you to choose the number of CPU cores to activate in each processor package.
- **Limit CPUID Maximum [Disabled]**
This item allows you to limit CPUID maximum value.
[Enabled] Allow legacy operating systems to boot even without support for CPUs with extended CPUID functions.
- **Execute Disable Bit [Enabled]**
This item allows you to enable or disable the No-Execution page protection technology.
- **Intel Virtualization Technology [Disabled]**
Intel Virtualization Technology (Intel VT) is a set of hardware enhancements to Intel server and client platforms that provide software-based virtualization solutions.
Intel VT allows a platform to run multiple operating systems and applications in independent partitions, allowing one computer system to function as multiple virtual systems.
- **Hardware Prefetch [Enabled]**
The processor fetches data and instructions from the memory into the cache that are likely to be required in the near future. This reduces the latency associated with memory reads.
- **Adjacent Cache Line Prefetch [Enabled]**
This item allows users to enable or disable the adjacent cache line prefetch feature.

3.2.2.6 SATA Configuration

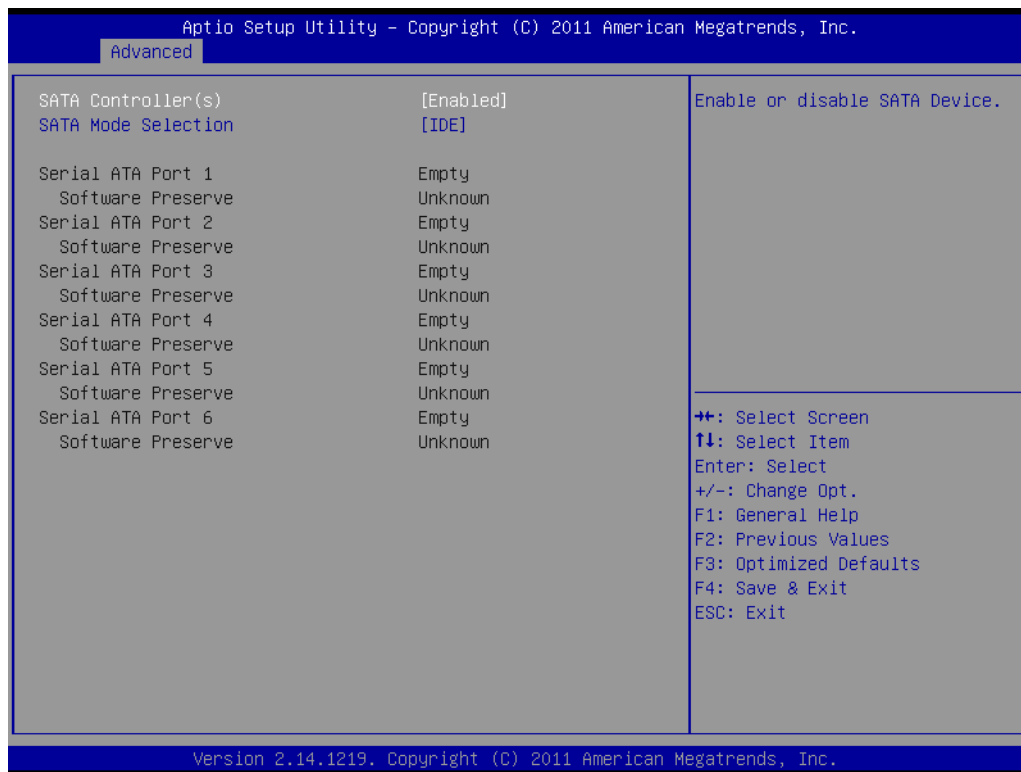

- **SATA Controllers [Enabled]**
Enable or disable SATA Function.

Note! This item appears only when you set SATA mode to "IDE Mode".



- **SATA Mode [IDE]**
This can be configured as IDE or AHCI mode.

3.2.2.7 Intel TXT Configuration

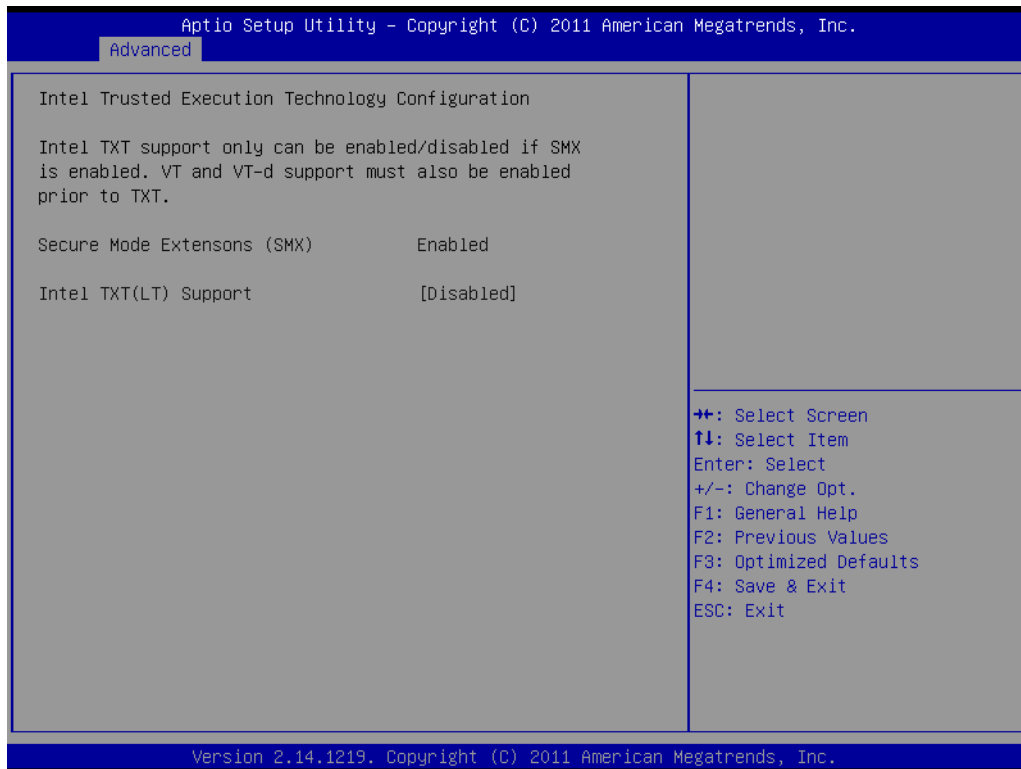

- **Secure Mode Extension (SMX) [Enabled]**
This item allows you to enable or disable the Intel Secure Mode Extensions (SMX) technology.
- **Intel TXT Configuration [Disabled]**
This item can be configured only when the Intel SMX, Intel Virtualization Technology (VT) and Intel Virtualization for Directed IO (VT-d) technologies are all enabled. This item allow you to enable or disable Intel Trusted Execution Technology.

3.2.2.8 AMT Configuration

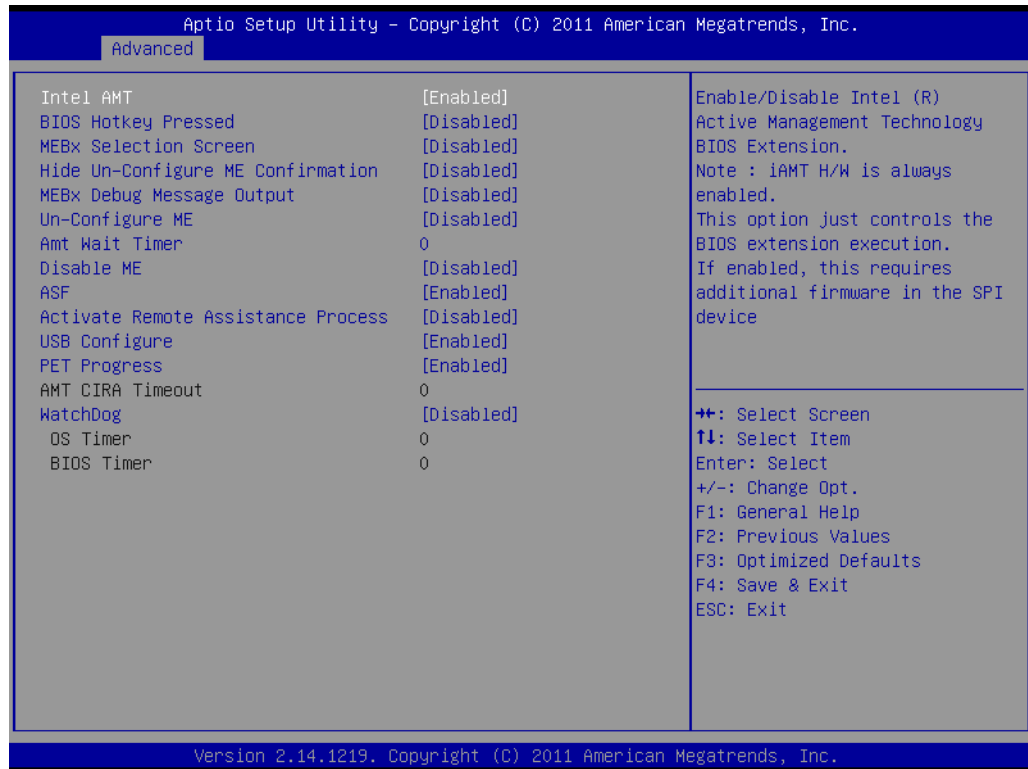

- **Intel AMT [Enabled]**
This item allows users to enable or disable Intel AMT BIOS extension.
- **BIOS Hotkey Pressed [Disabled]**
- **MEBx Select Screen [Disabled]**
- **Hide Un-Configure ME Confirmation [Disabled]**
- **MEBx Debug Message Output [Disabled]**
- **Un-Configure ME [Disabled]**
Sets this item to [Disabled] to unconfigure AMT/ME without using a password or set it as [Enabled] to use a password.
- **Amt Wait timer [0]**
- **Disable ME [Disabled]**
- **ASF [Enabled]**
- **Active Remote Assistance Process [Disabled]**
- **USB Configure [Enable]**
- **PET Progress [Enable]**
- **AMT CIRA Timeout [0]**
- **Watchdog [Disabled]**
When set to [Enabled], the Watchdog timer will monitor the time taken for each task performed by a software or hardware.
 - **OS Timer [0]**
 - **BIOS Timer [0]**

3.2.2.9 USB Configuration

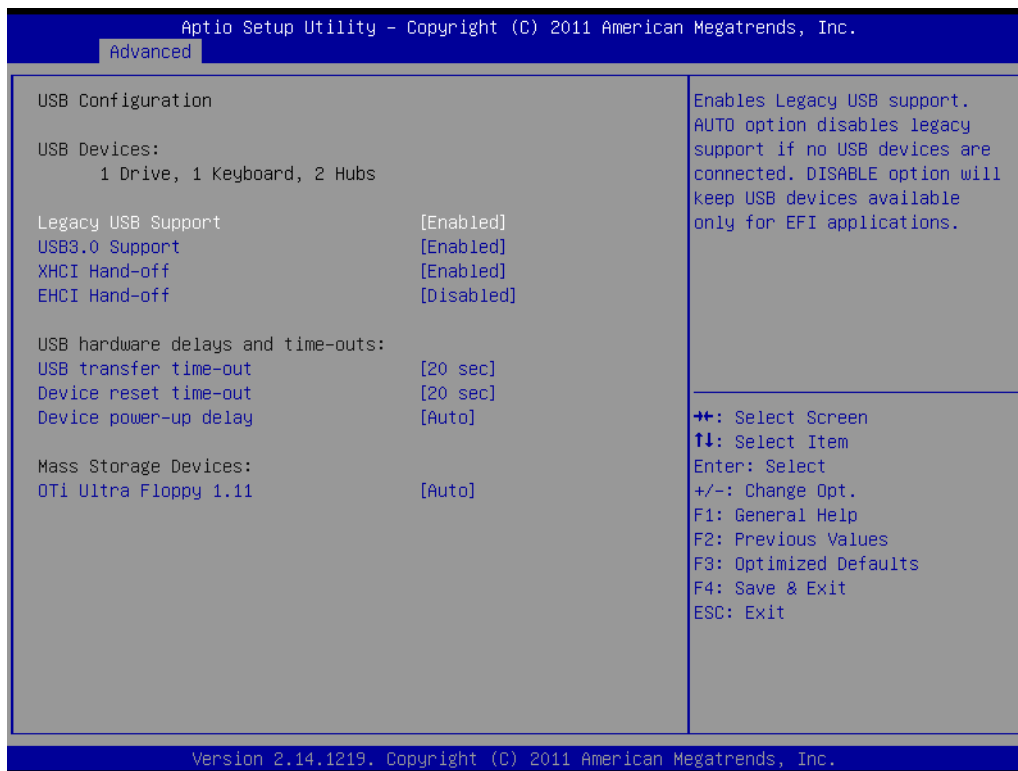

- **Legacy USB Support [Enabled]**
Enables support for legacy USB. Auto option disables legacy support if no USB devices are connected.
- **USB 3.0 Support [Enabled]**
- **XHCI Hand-off [Enabled]**
- **EHCI Hand-off**
This is just a workaround item under OS without EHCI hand-off support.
- **Device Reset time out**
USB mass storage device reset time out.
- **Mass Storage Devices [Auto]**
Shows USB mass storage device information.

3.2.2.10 SMART Settings

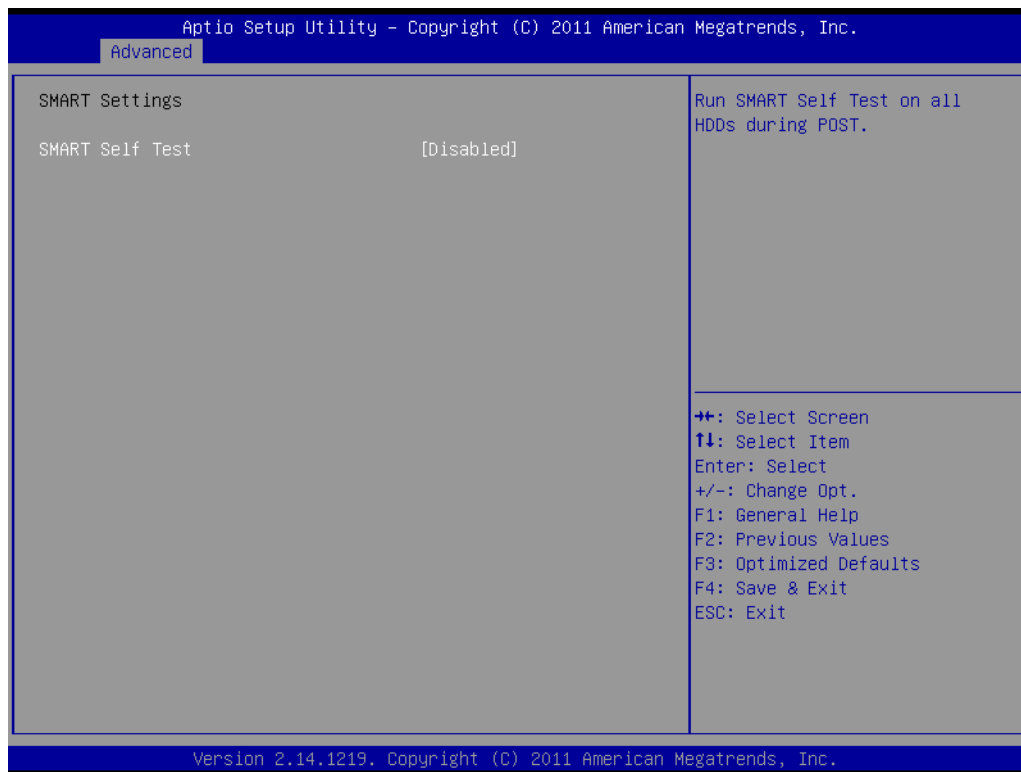

■ SMART Self Test [Disabled]

3.2.2.11 Super IO Configuration

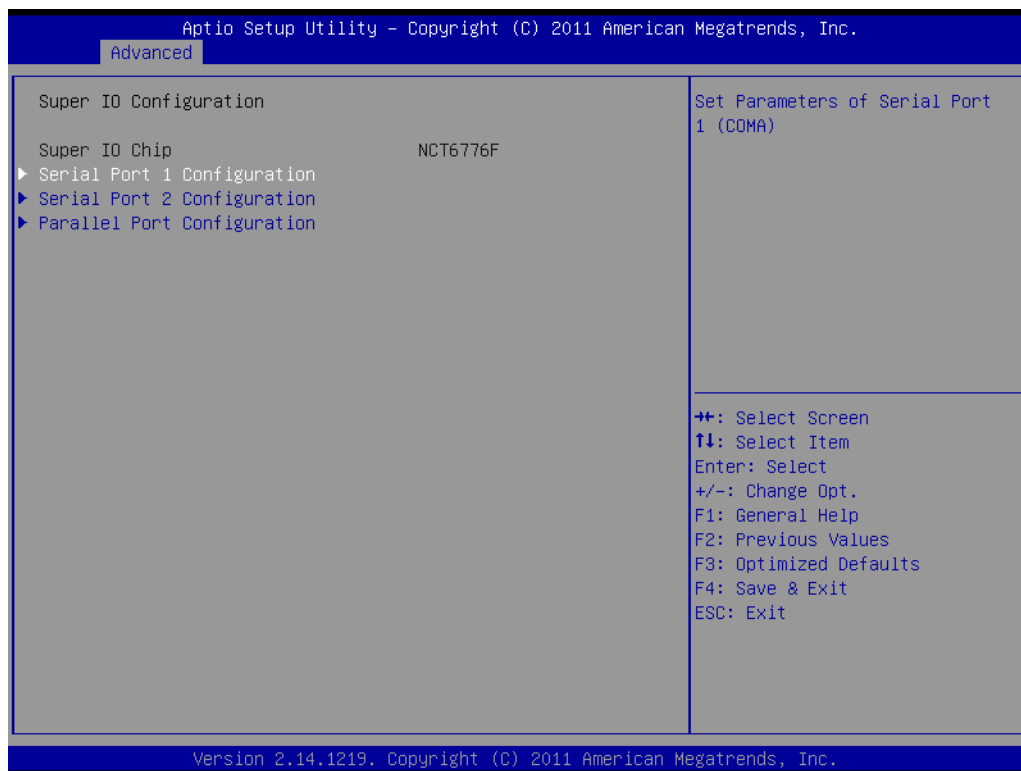

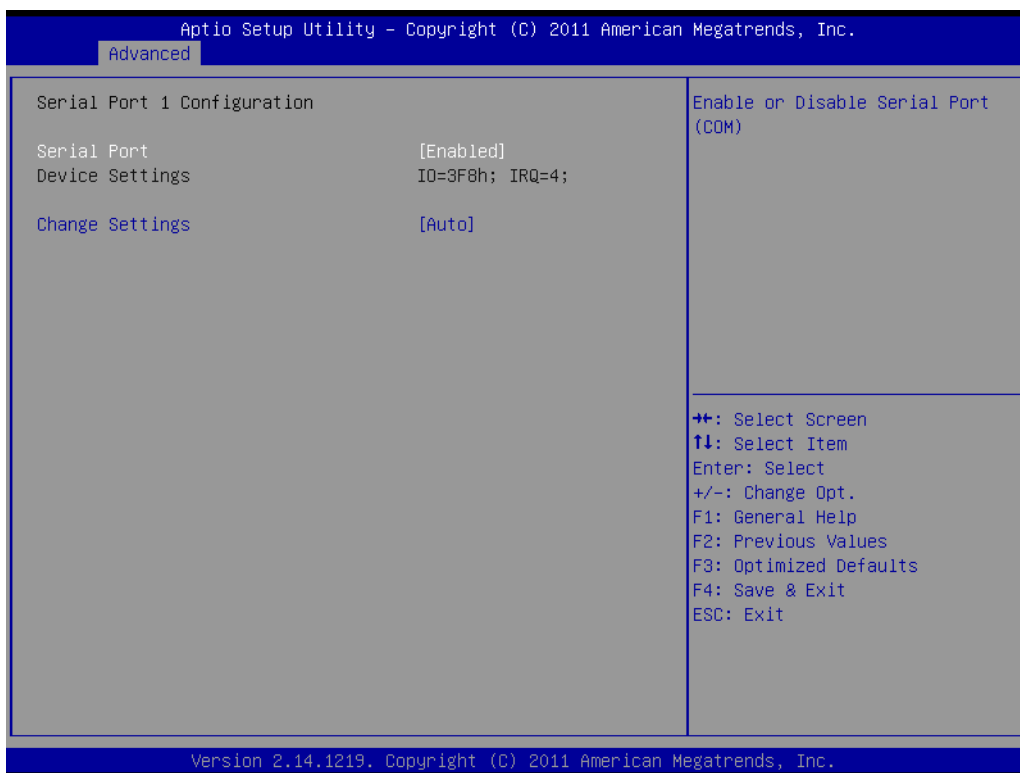

■ Serial Port 1 Configuration

- **Serial Port [Enabled]**
- **Change Settings [Auto]**

To select an optimal setting for serial port 1.

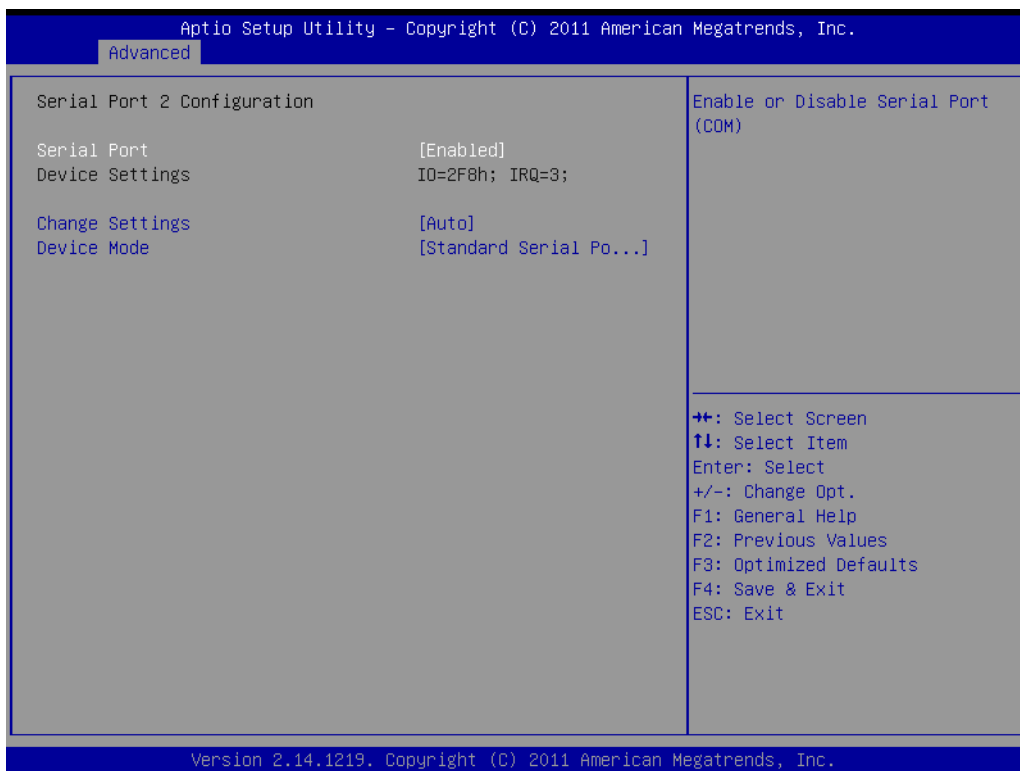

■ Serial Port 2 Configuration

- **Serial Port [Enabled]**
- **Change Setting [Auto]**
To select an optimal setting for serial port 2.
- **Device Mode**
Serial port 2 could be selected as “Standard serial port mode”, “IrDA 1.0 (HP SIR) mode”, or “ASKIR mode”.

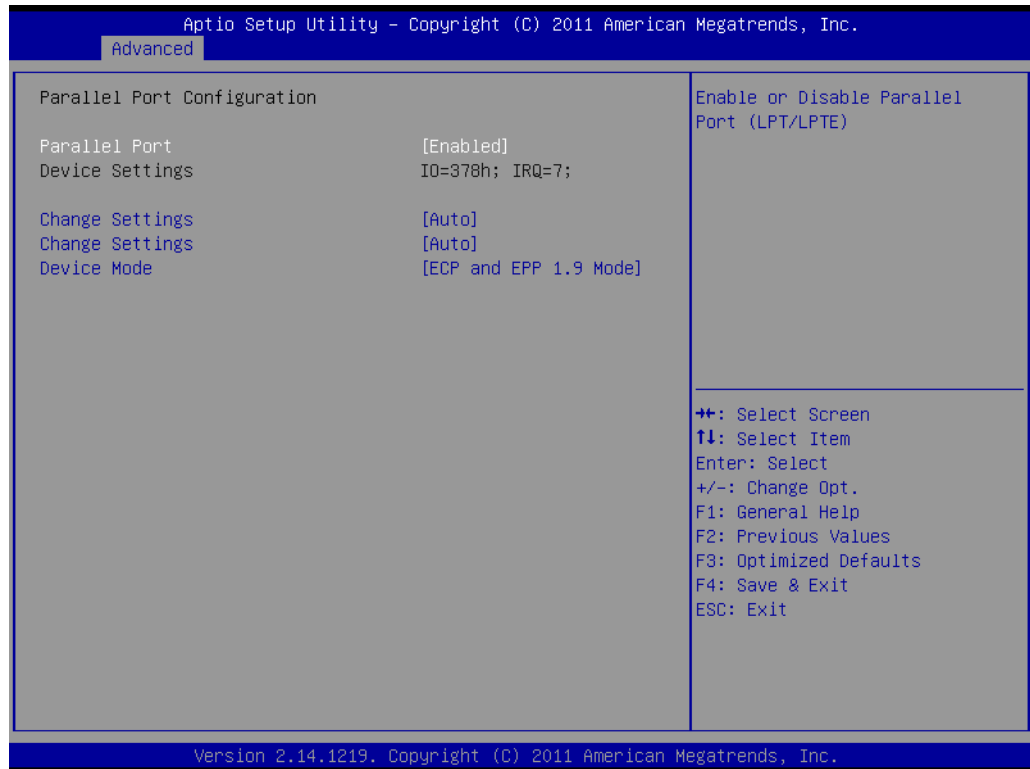

- **Parallel Port Configuration**
 - **Parallel Port [Enabled]**
To enable or disable Parallel Port.
 - **Change Settings [Auto]**
To select an optimal setting for parallel port.
 - **Device Mode [ECP and EPP 1.9 Mode]**

3.2.2.12 H/W Monitor

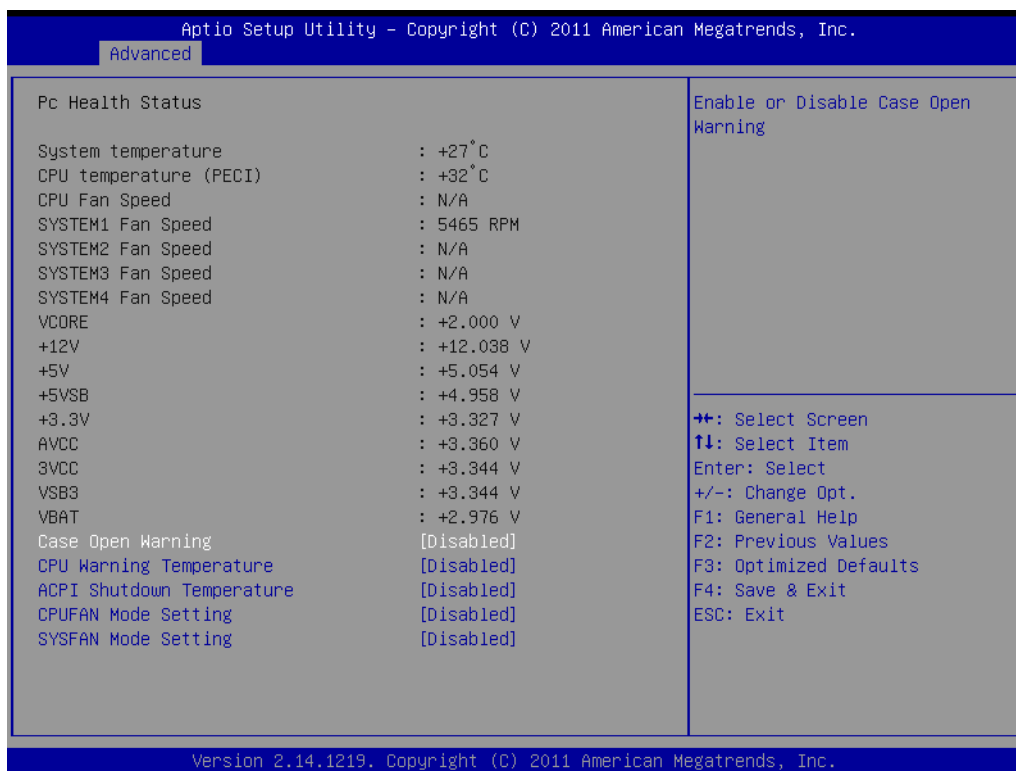

- **Case Open Warning [Disabled]**
Enable/Disable the chassis intrusion monitoring function. When enabled and the case is opened, the speaker beeps.
- **CPU Warning Temperature [Disabled]**
Use this to set the CPU warning temperature threshold. When the system reaches the warning temperature, the speaker will beep.
- **ACPI Shutdown Temperature [Disabled]**
Use this to set the ACPI shutdown temperature threshold. When the system reaches the shutdown temperature, it will be automatically shut down by ACPI OS to protect the system from overheating damage.
- **CPUFAN Mode Setting [Disabled]**
“Enable or Disable” CPUFAN Mode to SMART FAN setting.
- **SYSFAN Mode Setting [Disabled]**
“Enable or Disable” SYSFAN Mode to SMART FAN setting.

3.2.2.13 Second Super IO Configuration

AIMB-582QG2 version supports 2nd super IO for COM 3-6, so this page of the BIOS menu is to set respective serial port configuration.

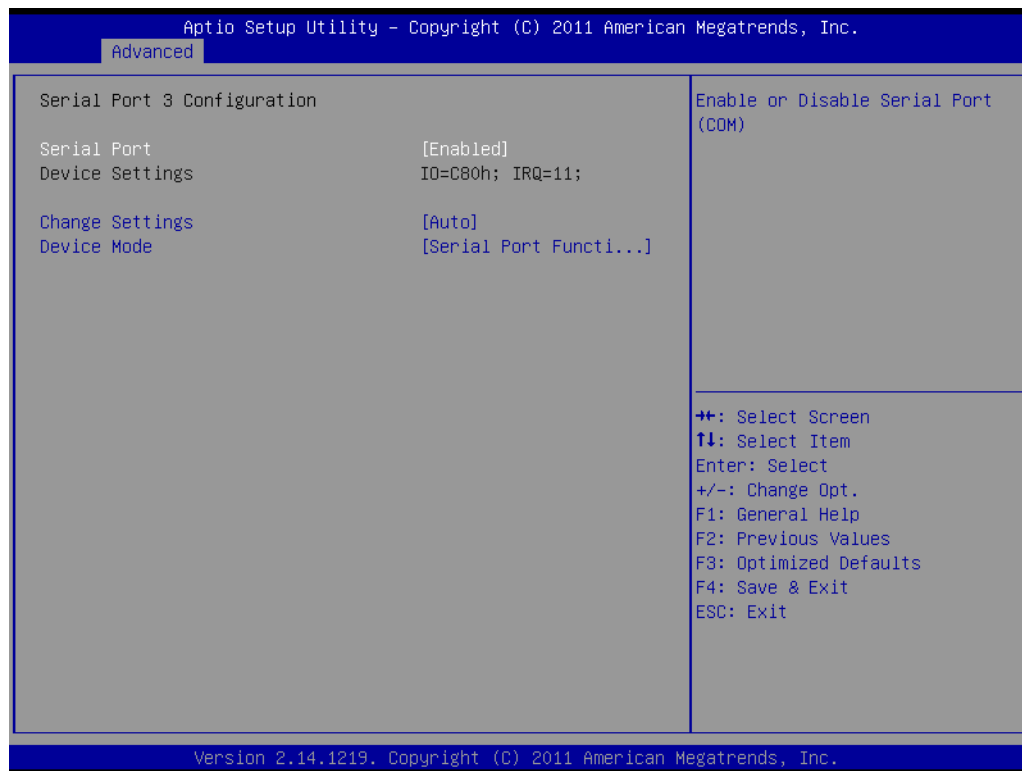

- **Serial Port 3 Configuration**
 - **Serial Port [Enabled]**
 - To “enable or disable” Serial Port 3.

- **Change Settings [Auto]**
To select an optimal setting for serial port 3.
- **Auto flow control**
When the COM is to set as RS-485, it supports auto flow control function.

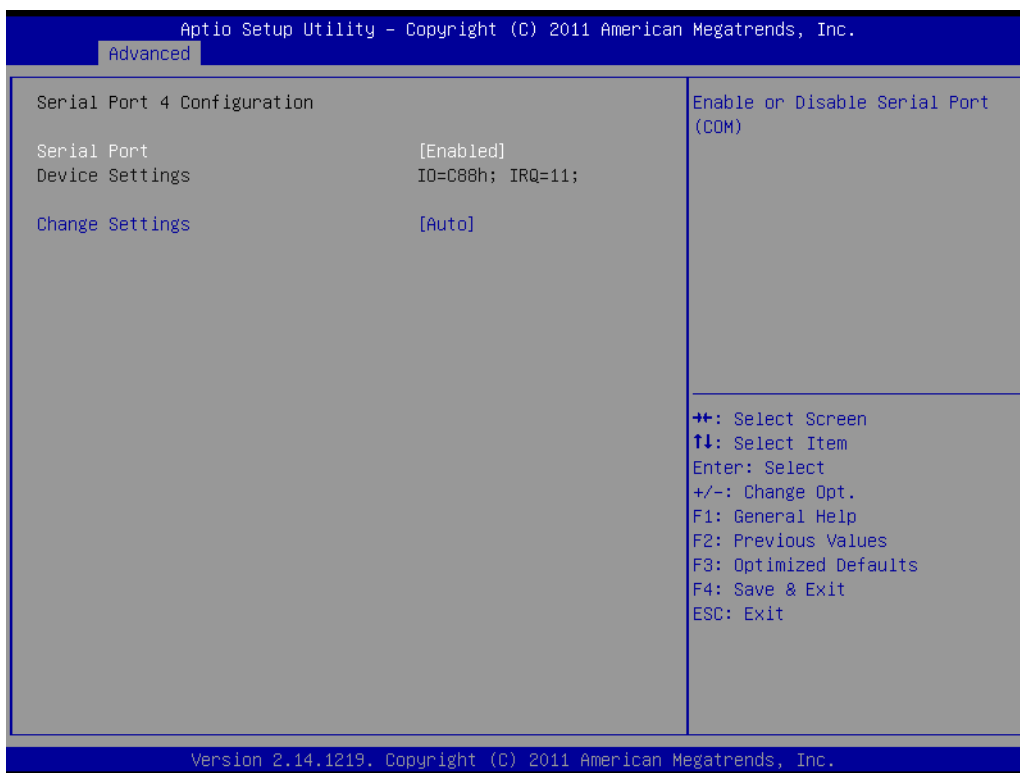

- **Serial Port 4 Configuration**
 - **Serial Port [Enabled]**
To "enable or disable" serial port 4.
 - **Change Settings [Auto]**
To select an optimal setting for serial port 4.

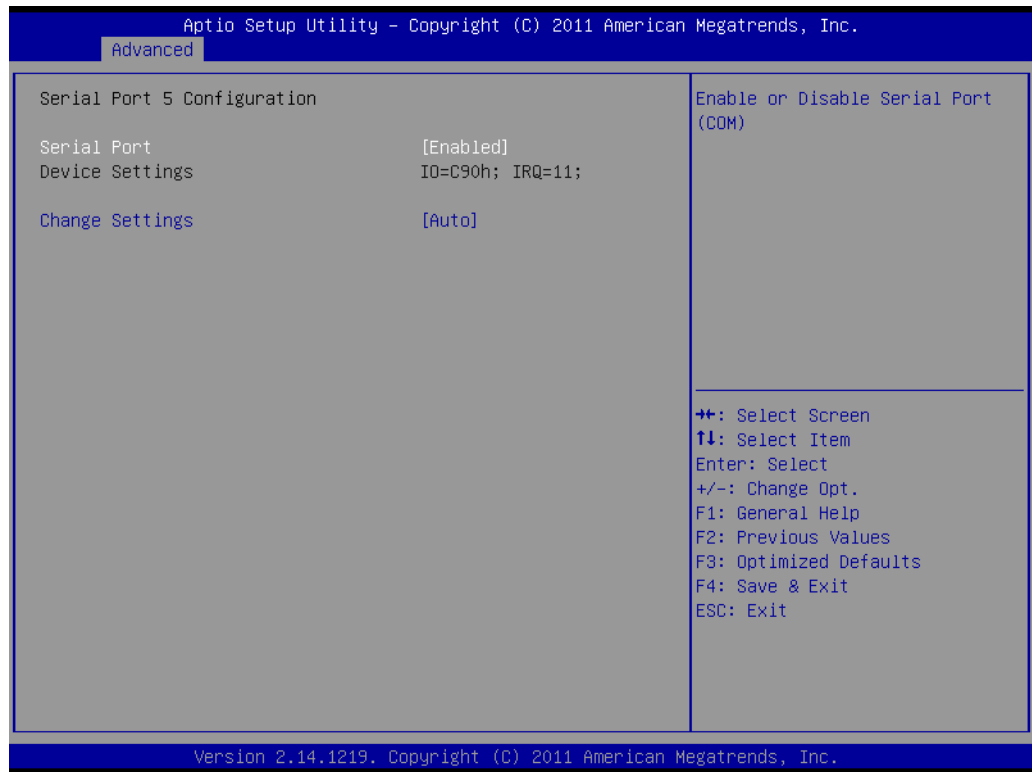

- **Serial Port 5 Configuration**
 - **Serial Port [Enabled]**
To “enable or disable” serial port 5.
 - **Change Settings [Auto]**
To select an optimal setting for serial port 5.



- **Serial Port 6 Configuration**
 - **Serial Port [Enabled]**
To “enable or disable” serial port 6.
 - **Change Setting [Auto]**
To select an optimal setting for serial port 6.

3.2.2.14 Serial Port Console Redirection

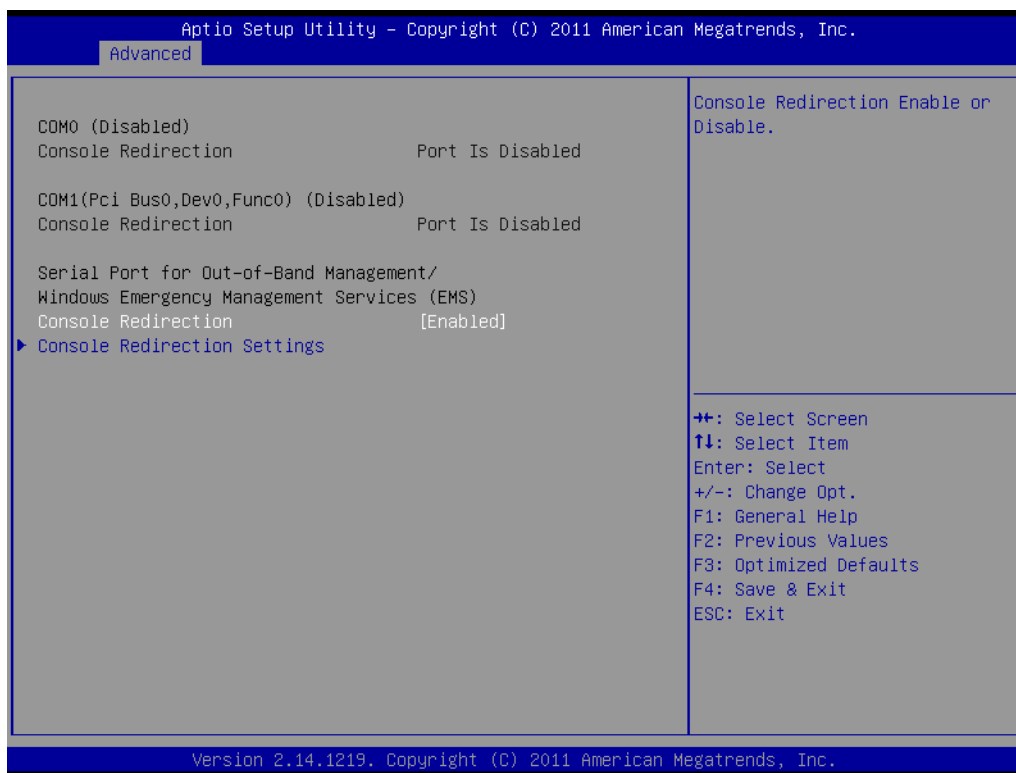

- **Console Redirection [Enabled]**
Enable or disable the console redirection feature

3.2.2.15 CPU PPM Configuration

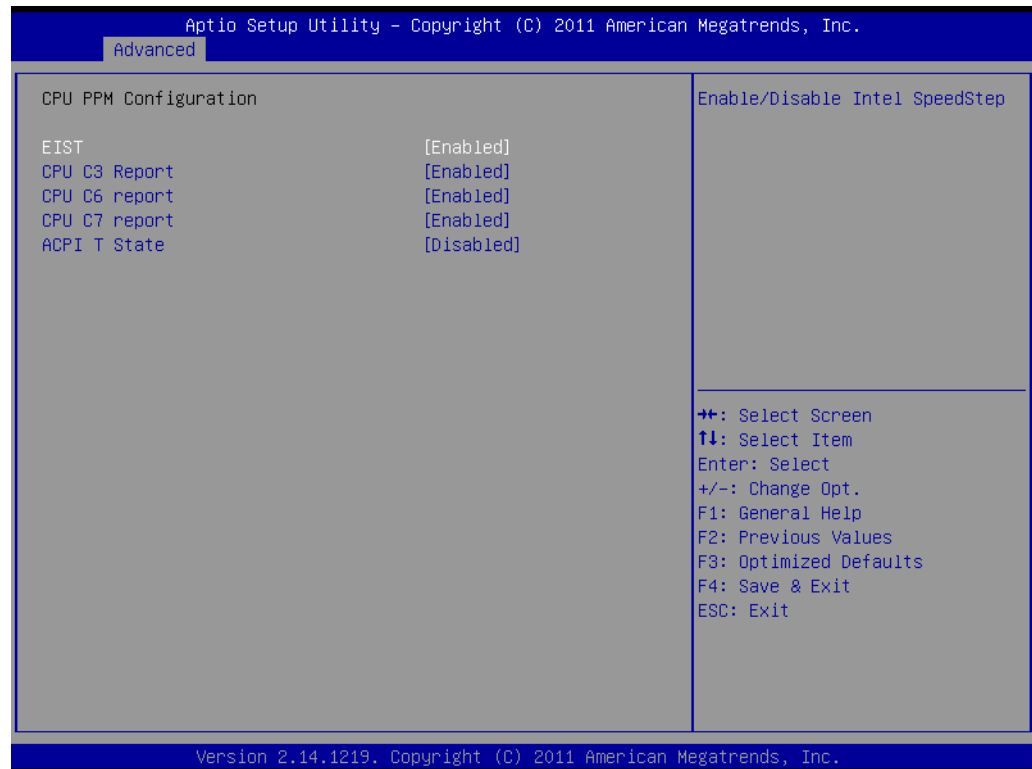

- **EIST [Enabled]**
This item can enable / disable Intel CPU speedstep.

3.3 Chipset Configuration Setting

Select the chipset tab from the BIOS setup screen to enter the Chipset Setup screen. Users can select any item in the left frame of the screen, such as PCI express Configuration, to go to the sub menu for that item. Users can display a Chipset Setup option by highlighting it using the <Arrow> keys. All Chipset Setup options are described in this section. The Chipset Setup screens are shown below. The sub menus are described on the following pages.

3.3.1 PCH-IO Configuration

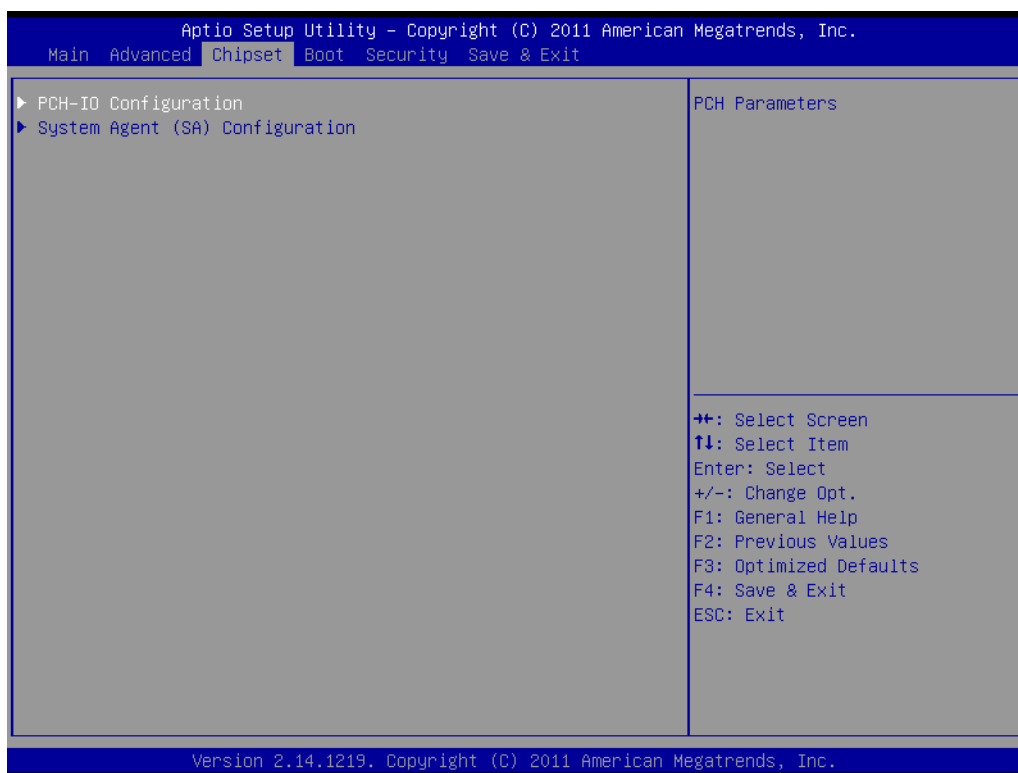

3.3.1.1 PCI Express Configuration

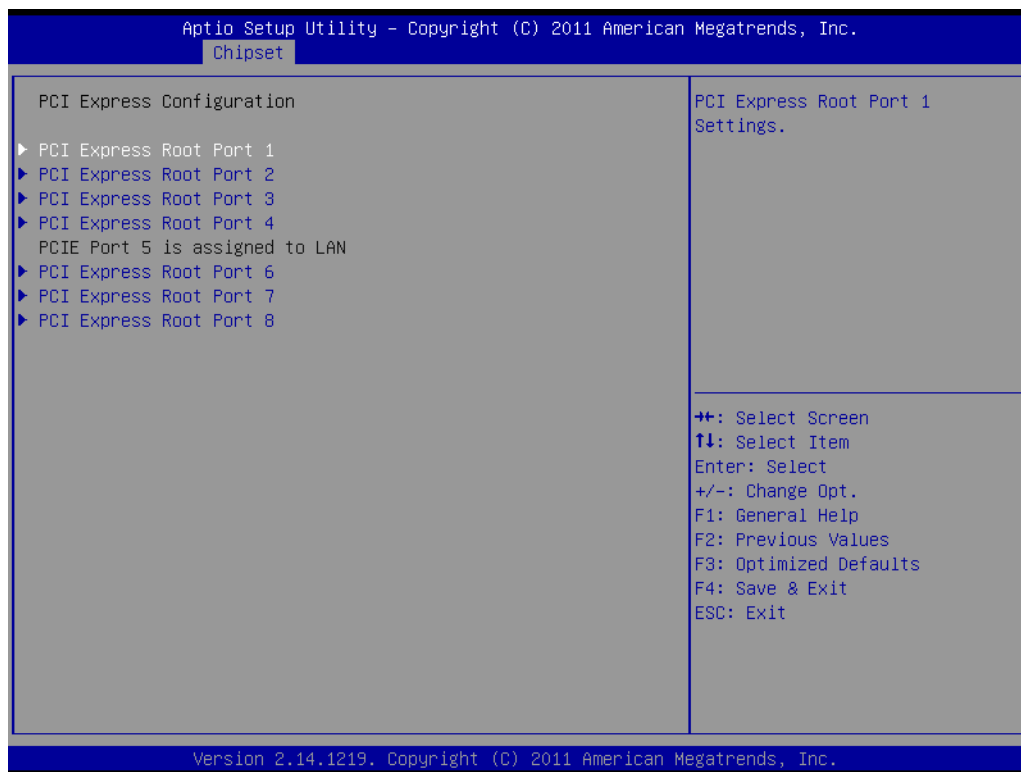
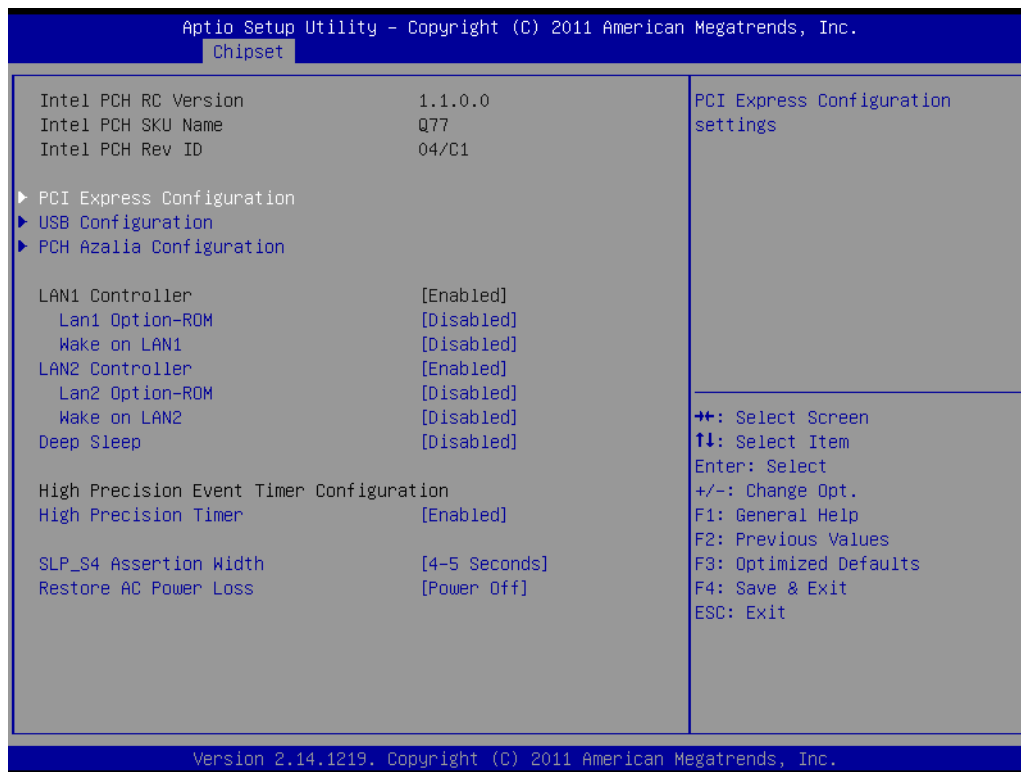

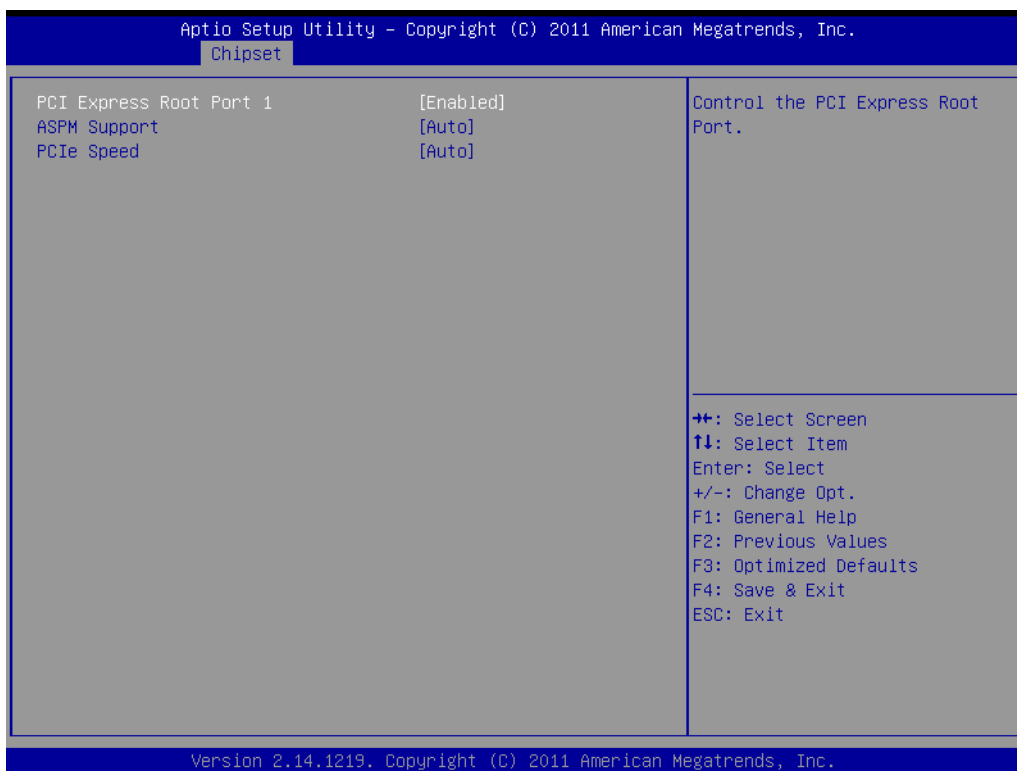

- **PCI Express Root Port 1 [Enabled]**
- **ASPM Support [Auto]**
- **PCIe Speed [Auto]**

3.3.1.2 USB Configuration

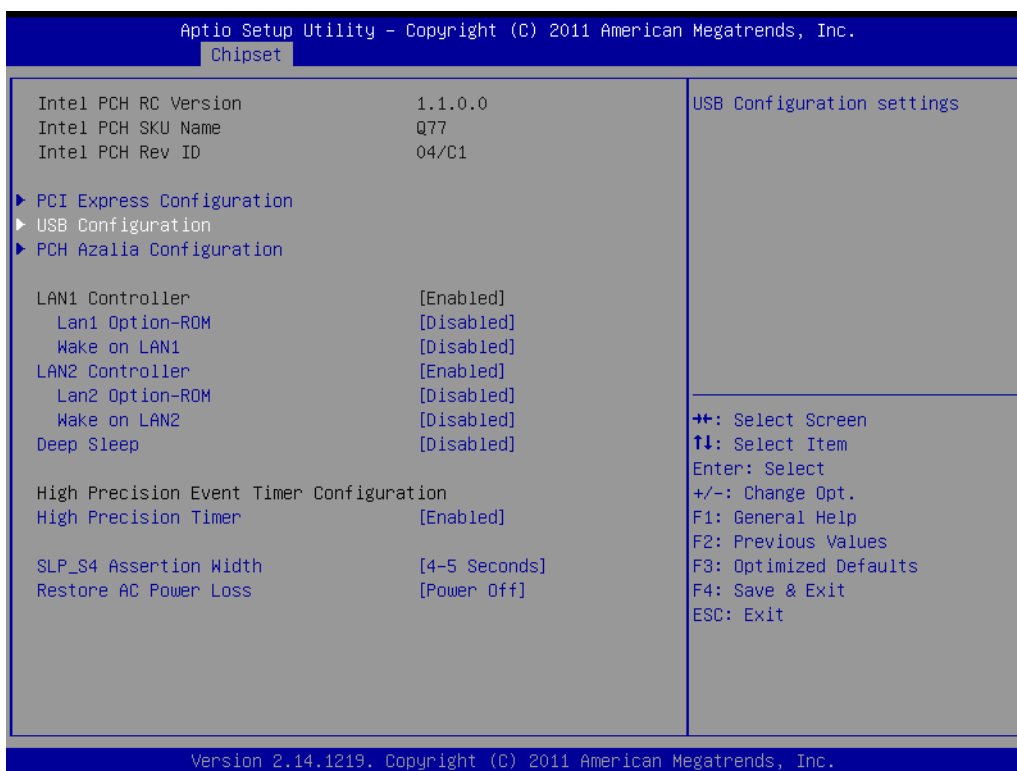

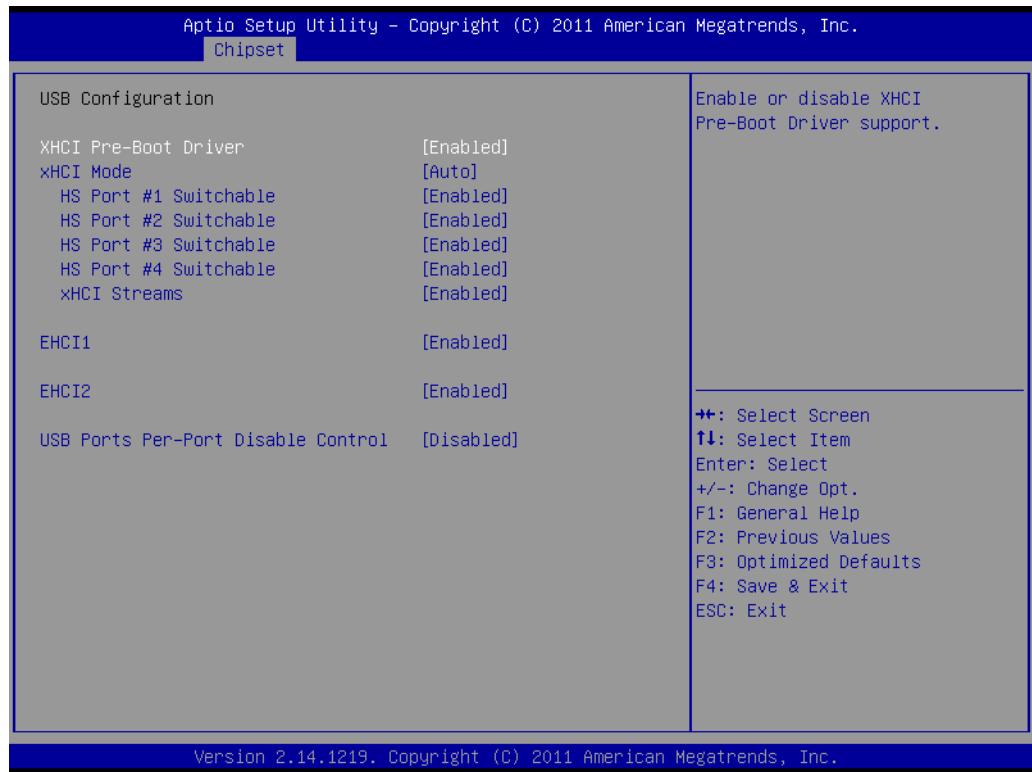

- **XHCI Pre-Boot Driver [Enabled]**
Enable or disable XHCI Pre-Boot Driver support.

3.3.1.3 PCH Azalia Configuration

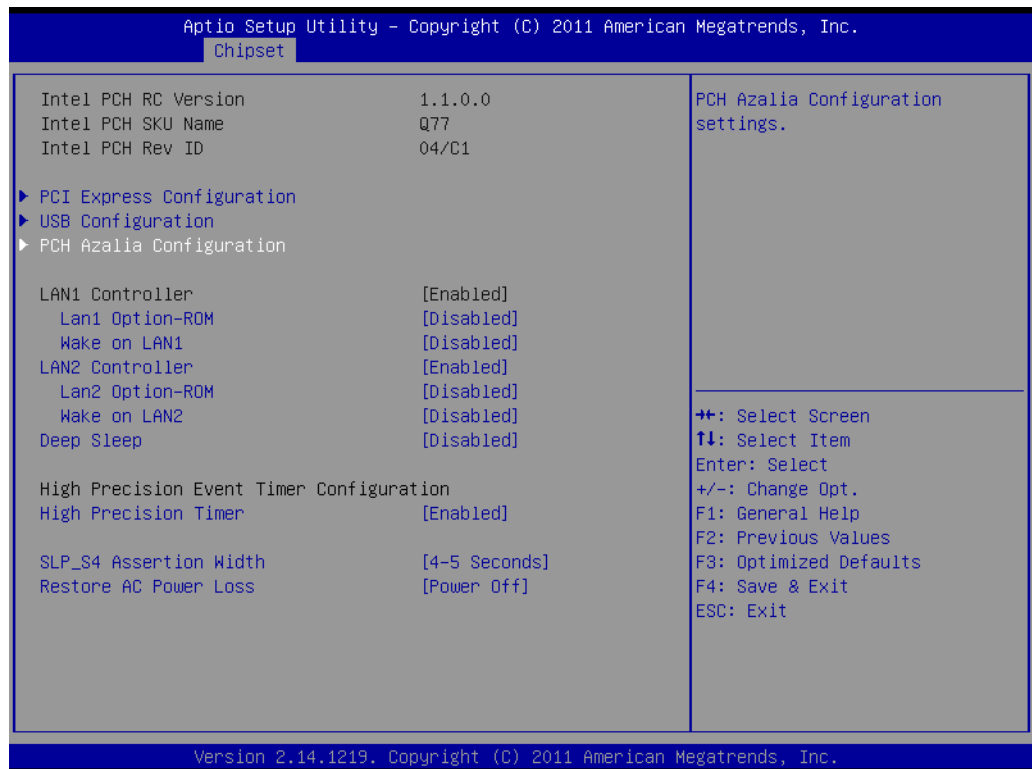



■ **Azalia [Auto]**

This item set for control Detection of the Azalia device.

[Disabled] = Azalia will be unconditionally disabled.

[Enabled] = Azalia will be unconditionally enabled

[Auto] = Azalia will be enabled if present, disabled otherwise.

3.3.2 System Agent (SA) Configuration

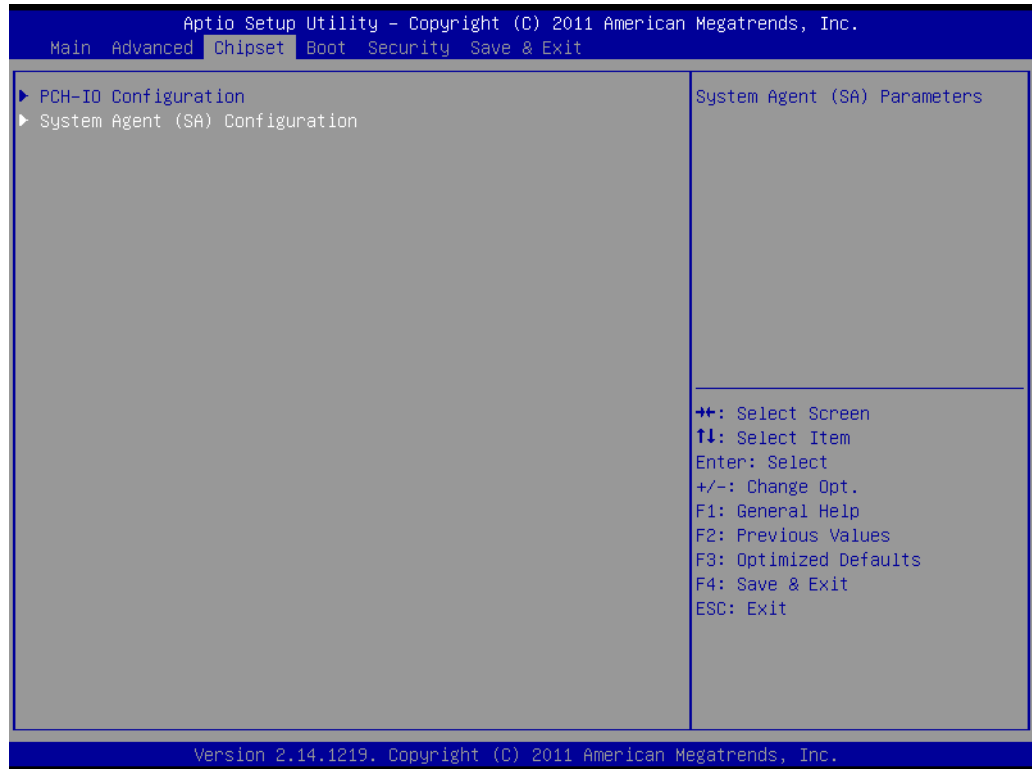

3.3.2.1 C-State Pre Wake



- **C-State Pre-Wake [Enabled]**
Disable or enable C-State Pre-Wake feature for ARAT.

3.3.2.2 Graphics Configuration



- **Primary Display [Auto]**
Select the video device which will be activated during POST.
- **LCD control**

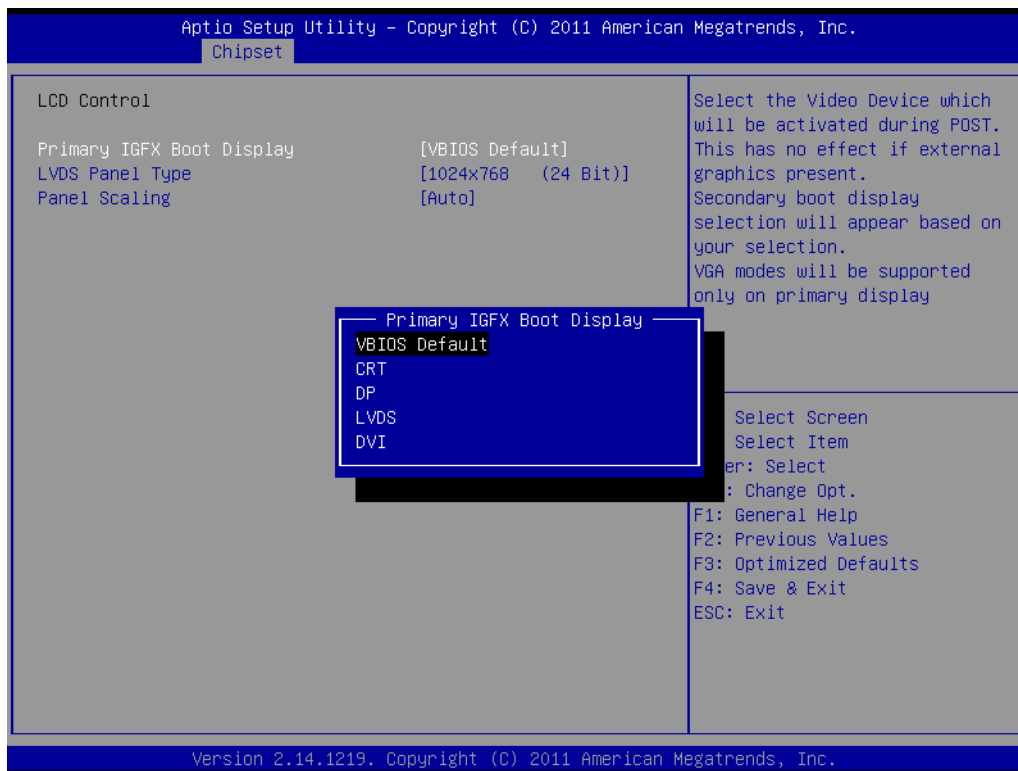

■ **Primary IGFX Boot Display [VBIOS Default]**

Select the video device which will be activated during POST. Secondary boot display selection will appear based on customer's selection.

Note! *When BIOS set as " Auto", only CRT is supported as the single display under DOS.*



Note! *The triple display can only working PASS under Windows 7, not supported in Windows XP and Linux, and the 2nd and 3rd display can not work under DOS.*



Here is 2-3 displays combination table and all of these combinations are verified and tested properly already.

BIOS Setting Primary/Secondary	BIOS	DOS	OS
CRT	PASS	PASS	PASS
DVI	PASS	PASS	PASS
DVI=>HDMI	PASS	PASS	PASS
DP	PASS	PASS	PASS
LVDS	PASS	PASS	PASS
CRT+DVI=>HDMI	PASS	PASS	PASS
CRT+DVI	PASS	PASS	PASS
CRT+DP	PASS	PASS	PASS
CRT+LVDS	PASS	PASS	PASS
DVI+LVDS	PASS	PASS	PASS
DVI+DP	PASS	PASS	PASS
LVDS+DP	PASS	PASS	PASS
LVDS+DVI=>HDMI	PASS	PASS	PASS
DP+DVI=>HDMI	PASS	PASS	PASS
CRT+DVI+DP	N/A	N/A	PASS
CRT+DVI+LVDS	N/A	N/A	PASS
CRT+DP+LVDS	N/A	N/A	PASS
CRT+DP+DVI=>HDMI	N/A	N/A	PASS
CRT+LVDS+DVI=>HDMI	N/A	N/A	PASS
LVDS+DP+DVI	N/A	N/A	PASS
LVDS+DP+DVI=>HDMI	N/A	N/A	PASS

■ Active LVDS

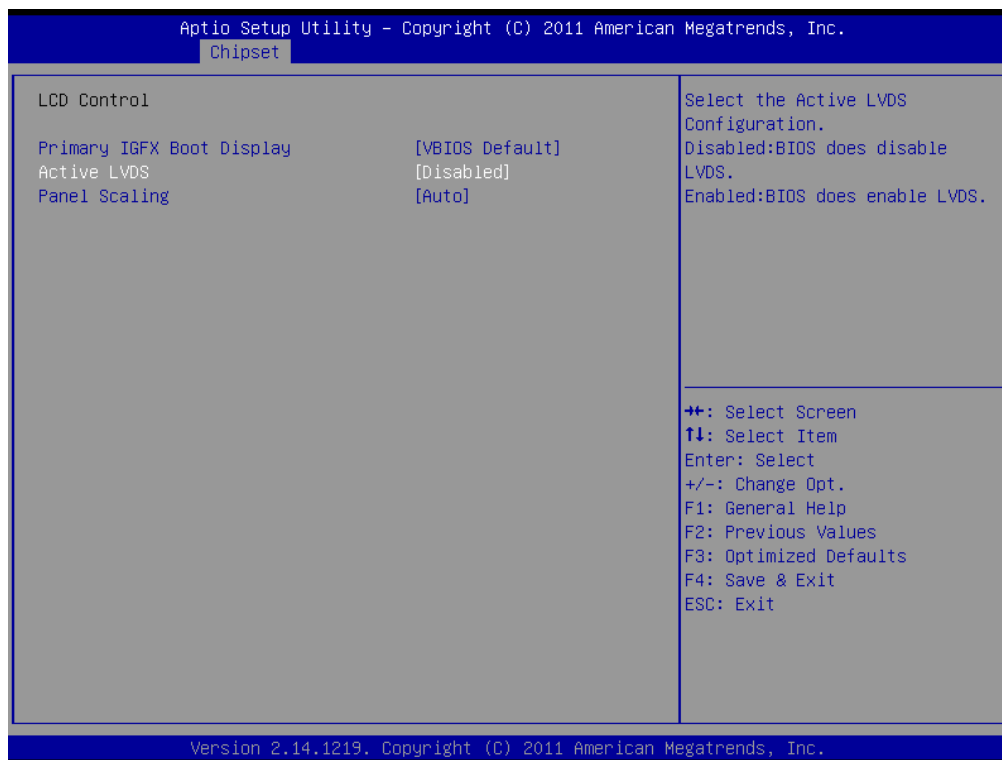

■ Active LVDS [Disable]

Note! When you enable LVDS type, customers can choose different resolution settings from the table. Default resolution setting is "800 x 600 18-bit" (see below)

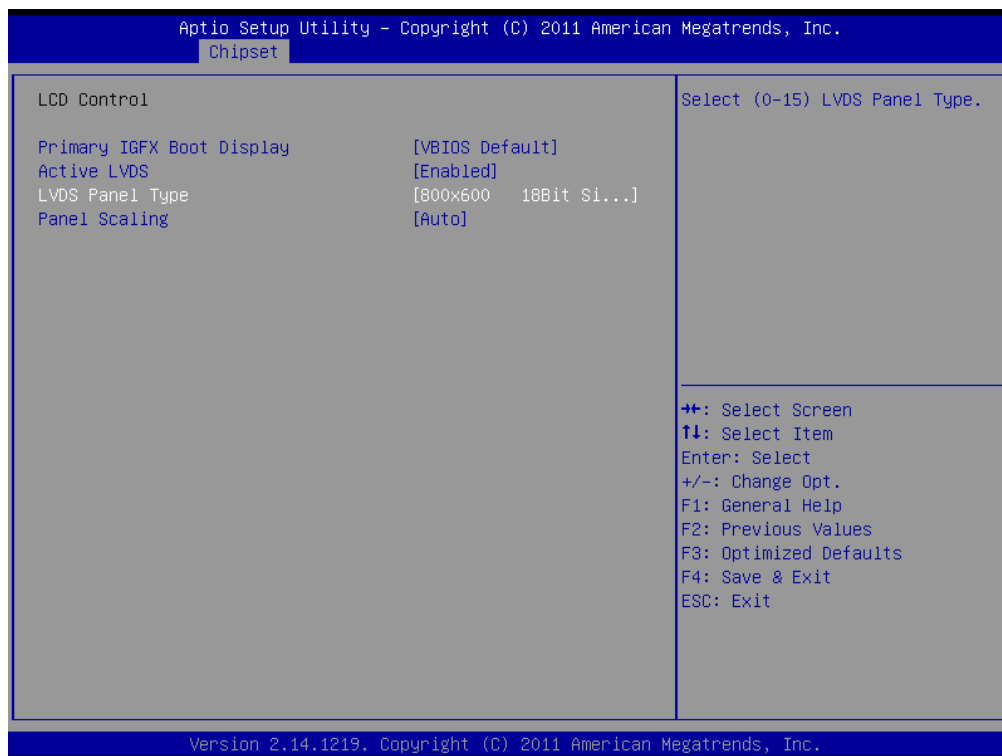

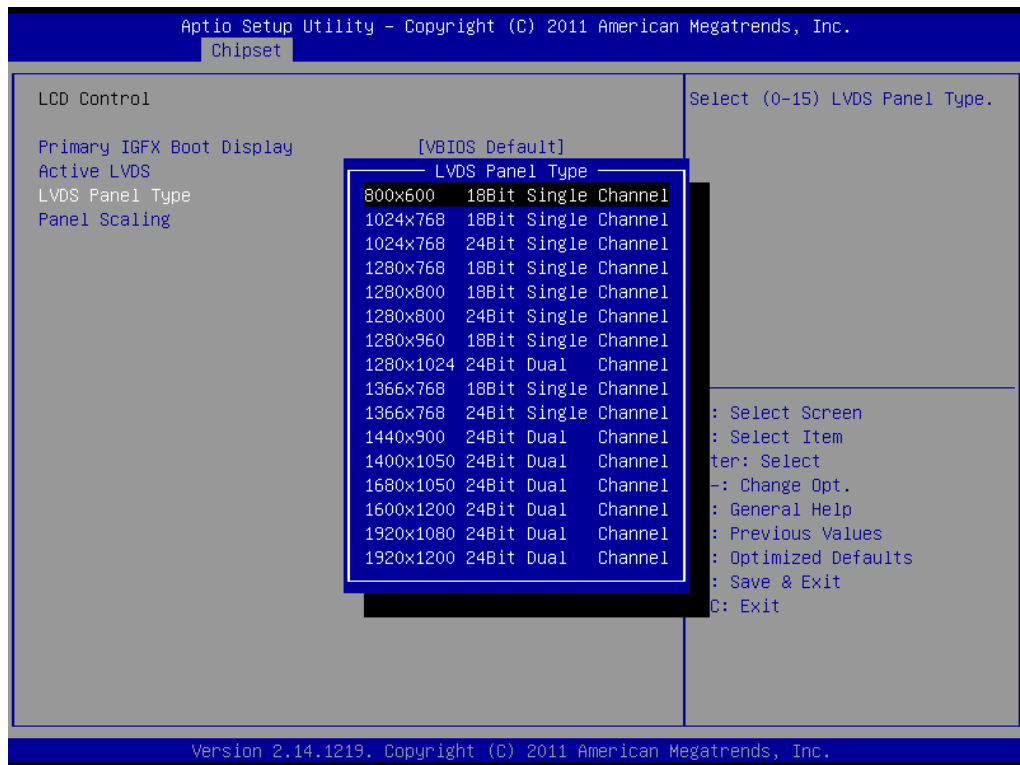

3.3.2.3 NB PCIe Configuration

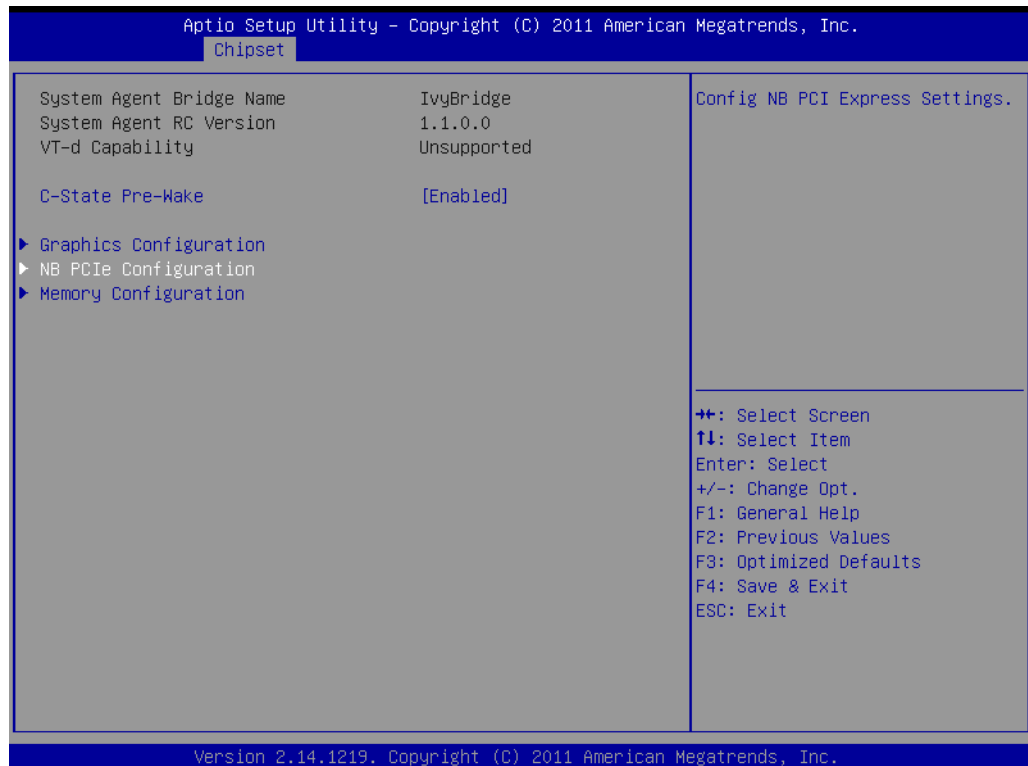

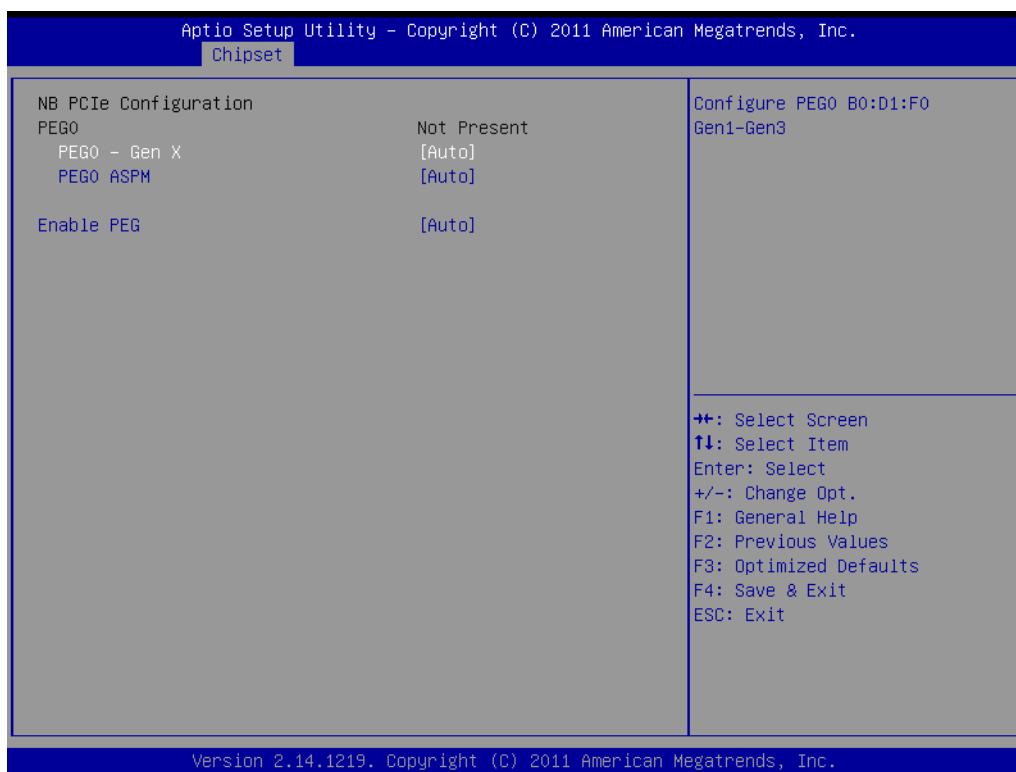

3.4 Boot Setting

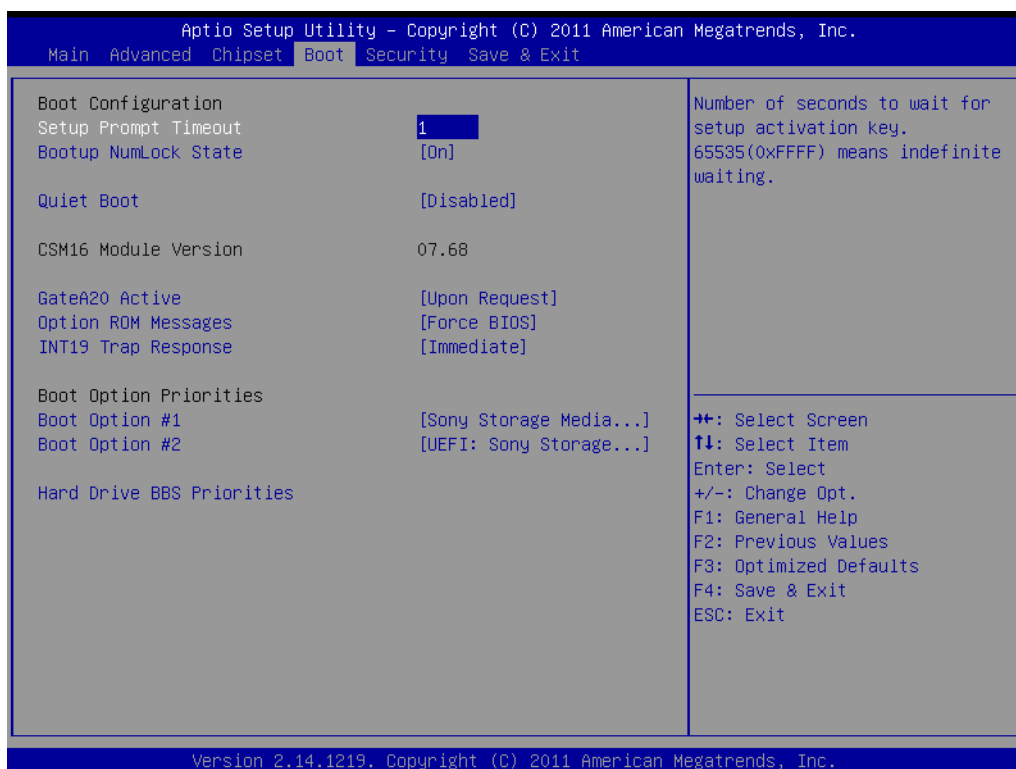

- **Setup Prompt Timeout**
User the <+> and <-> keys to adjust the number of seconds to wait for setup activation key.
- **Bootup NumLock State [On]**

- On or Off power on state for the NumLock
- **Quiet Boot [Disabled]**
If this option is set to disabled, the BIOS displays normal POST messages. If enabled, an OEM logo is shown instead of POST messages.
- **Option ROM Messages [Force BIOS]**
Force BIOS or Keep Current to set the display mode
- **Interrupt 19 Capture**
Enable or disable Option ROM to trap Interrupt 19
- **Boot Option #1/#2**
Choose boot priority from boot device

3.5 Security Setting

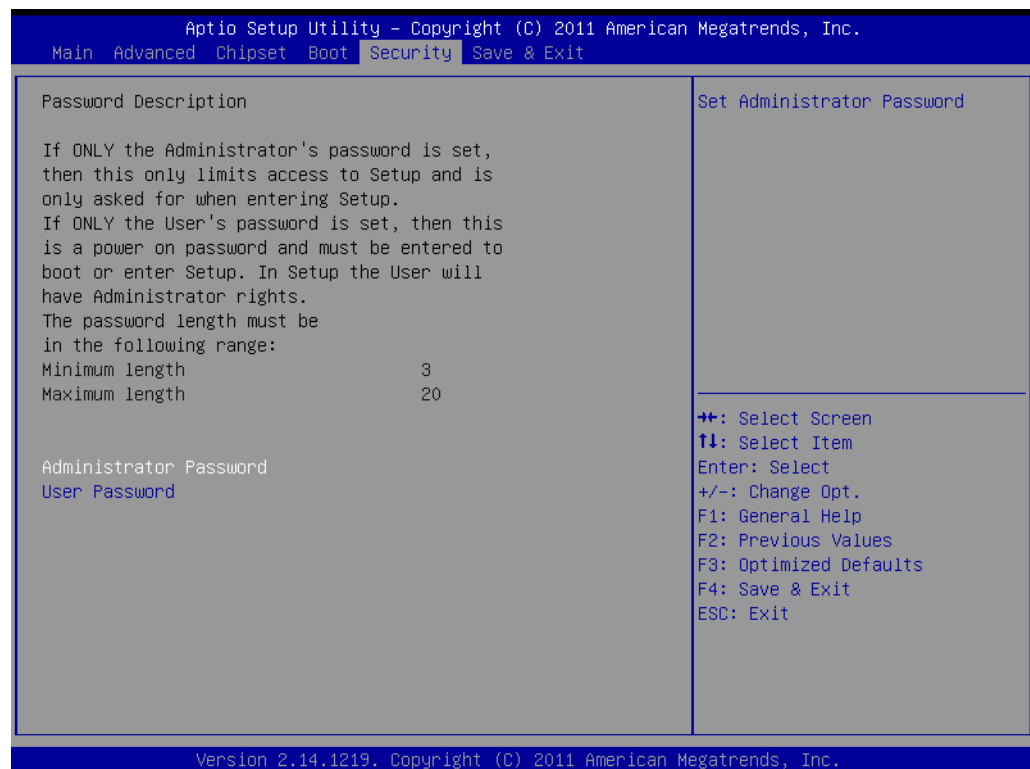

- **Administrator Password**
Select this option and press <ENTER> to access the sub menu, and then type in the password. Set the Administrator password.
- **User Password**
Select this option and press <ENTER> to access the sub menu, and then type in the password. Set the User Password.

3.6 Save & Exit Configuration



■ Save Changes and Exit

When users have completed system configuration, select this option to save changes, exit BIOS setup menu and reboot the computer to take effect all system configuration parameters.

1. Select Exit Saving Changes from the Exit menu and press <Enter>. The following message appears: Save Configuration Changes and Exit Now? [Ok] [Cancel]
2. Select Ok or cancel.

■ Discard Changes and Exit

Select this option to quit Setup without making any permanent changes to the system configuration.

1. Select Exit Discarding Changes from the Exit menu and press <Enter>. The following message appears: Discard Changes and Exit Setup Now? [Ok] [Cancel]
2. Select Ok to discard changes and exit. Discard Changes
Select Discard Changes from the Exit menu and press <Enter>.

■ Restore Default

The BIOS automatically configures all setup items to optimal settings when users select this option. Defaults are designed for maximum system performance, but may not work best for all computer applications. In particular, do not use the Defaults if the user's computer is experiencing system configuration problems. Select Restore Defaults from the Exit menu and press <Enter>.

■ Save as User Default

Save the all current settings as a user default.

■ Restore User Default

Restore all settings to user default values.

■ Boot Override

Shows the boot device types on the system.

Chapter 4

Software Introduction
& Service

4.1 Introduction

The mission of Advantech Embedded Software Services is to "Enhance quality of life with Advantech platforms and Microsoft® Windows® embedded technology." We enable Windows® Embedded software products on Advantech platforms to more effectively support the embedded computing community. Customers are freed from the hassle of dealing with multiple vendors (hardware suppliers, system integrators, embedded OS distributors) for projects. Our goal is to make Windows® Embedded Software solutions easily and widely available to the embedded computing community.

4.2 Value-Added Software Services

Software API: An interface that defines the ways by which an application program may request services from libraries and/or operating systems. Provides not only the underlying drivers required but also a rich set of user-friendly, intelligent and integrated interfaces, which speeds development, enhances security and offers add-on value for Advantech platforms. It plays the role of catalyst between developer and solution, and makes Advantech embedded platforms easier and simpler to adopt and operate with customer applications.

4.2.1 Software API

4.2.1.1 Control

GPIO



General Purpose Input/Output is a flexible parallel interface that allows a variety of custom connections. It allows users to monitor the level of signal input or set the output status to switch on/off the device. Our API also provides Programmable GPIO, which allows developers to dynamically set the GPIO input or output status.

SMBus



SMBus is the System Management Bus defined by Intel Corporation in 1995. It is used in personal computers and servers for low-speed system management communications. The SMBus API allows a developer to interface a embedded system environment and transfer serial messages using the SMBus protocols, allowing multiple simultaneous device control.

4.2.1.2 Display

Brightness Control



The Brightness Control API allows a developer to access embedded devices and easily control brightness.

Backlight



The Backlight API allows a developer to control the backlight (screen) on/off in embedded devices.

4.2.1.3 Monitor

Watchdog



A watchdog timer (WDT) is a device that performs a specific operation after a certain period of time if something goes wrong and the system does not recover on its own. A watchdog timer can be programmed to perform a warm boot (restarting the system) after a certain number of seconds.

Hardware Monitor



The Hardware Monitor (HWM) API is a system health supervision API that inspects certain condition indexes, such as fan speed, temperature and voltage.

4.2.1.4 Power Saving

CPU Speed



Makes use of Intel SpeedStep technology to save power consumption. The system will automatically adjust the CPU speed depending on the system loading.

System Throttling

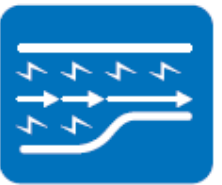

Refers to a series of methods for reducing power consumption in computers by lowering the clock frequency. This API allows the user to adjust the clock from 87.5% to 12.5%.

4.2.2 Software Utility

BIOS Flash

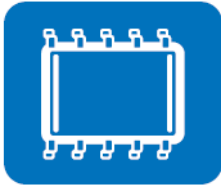

The BIOS Flash utility allows customers to update the flash ROM BIOS version, or use it to back up current BIOS by copying it from the flash chip to a file on the customers' disk. The BIOS Flash utility also provides a command line version and an API for fast implementation into customized applications.

Embedded Security ID



The embedded application is the most important property of a system integrator. It contains valuable intellectual property, design knowledge and innovation - but it is easy to be copy. Embedded Security ID utility provides reliable security functions for customers to secure their application data within embedded BIOS.

Monitoring



Monitoring is a utility for customers to monitor system health, like voltage, CPU and system temperature and fan speed. These items are important to a device, if critical errors occur and are not solved immediately, permanent damage may be caused.

eSOS



eSOS is a small OS stored in BIOS ROM. It will boot up in case of a main OS crash. It will diagnose the hardware status, and then send an e-mail to the designated administrator. eSOS also provides for remote connection via Telnet server and FTP server so the administrator can attempt to rescue the system. Note: This function requires BIOS customization.

Chapter 5

Chipset Software
Installation Utility

5.1 Before You Begin

To facilitate the installation of the enhanced display drivers and utility software, read the instructions in this chapter carefully. The drivers for AIMB-582 are located on the software installation CD. The driver in the folder of the driver CD will guide and link you to the utilities and drivers under a Windows system. Updates are provided via Service Packs from Microsoft*.

Note! *The files on the software installation CD are compressed. Do not attempt to install the drivers by copying the files manually. You must use the supplied SETUP program to install the drivers.*



Before you begin, it is important to note that most display drivers need to have the relevant software application already installed in the system prior to installing the enhanced display drivers. In addition, many of the installation procedures assume that you are familiar with both the relevant software applications and operating system commands. Review the relevant operating system commands and the pertinent sections of your application software's user manual before performing the installation.

5.2 Introduction

The Intel® Chipset Software Installation (CSI) utility installs the Windows INF files that outline to the operating system how the chipset components will be configured. This is needed for the proper functioning of the following features:

- Core PCI PnP services
- IDE Ultra ATA 100/66/33 and Serial ATA interface support
- USB 1.1/2.0 support (USB 2.0 driver needs to be installed separately for Win98)
- Identification of Intel® chipset components in the Device Manager

Note! *This utility is used for the following versions of Windows, and it has to be installed **before** installing all the other drivers:*



- Windows 7 (32-bit)
- Windows 7 (64-bit)
- Windows XP professional edition (32-bit)
- Windows XP professional edition (64-bit)

5.3 Windows XP/Windows 7 Driver Setup

1. Insert the driver CD into your system's CD-ROM drive. Navigate to the "01. Chip" folder and click "infinst.autol.exe" to complete driver installation.

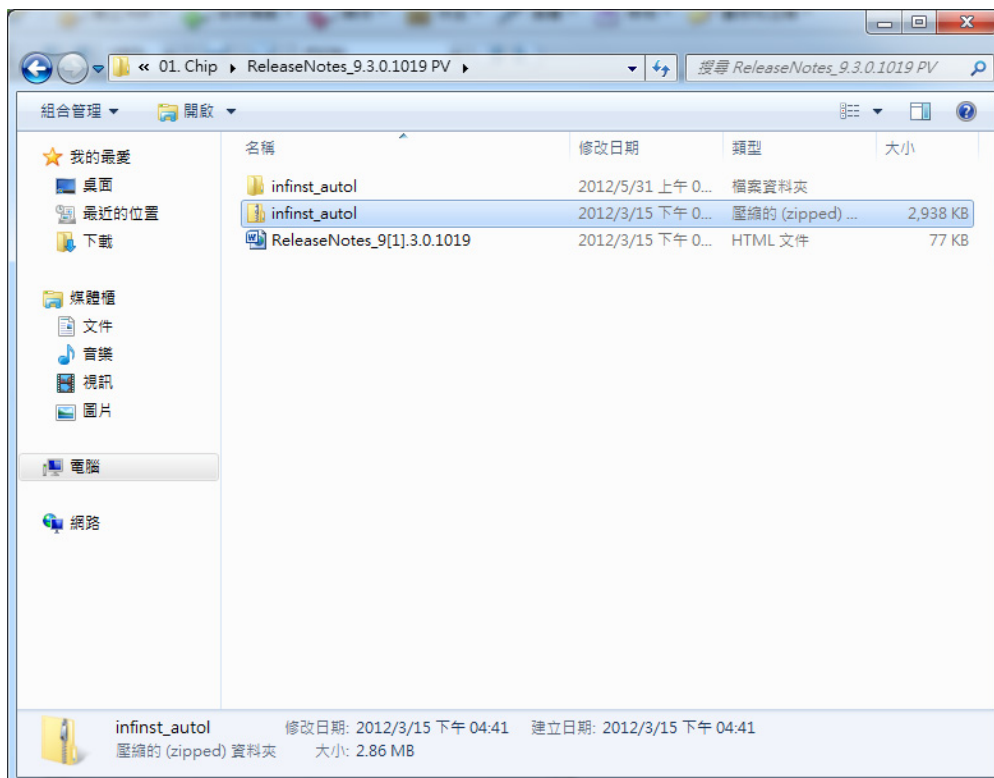
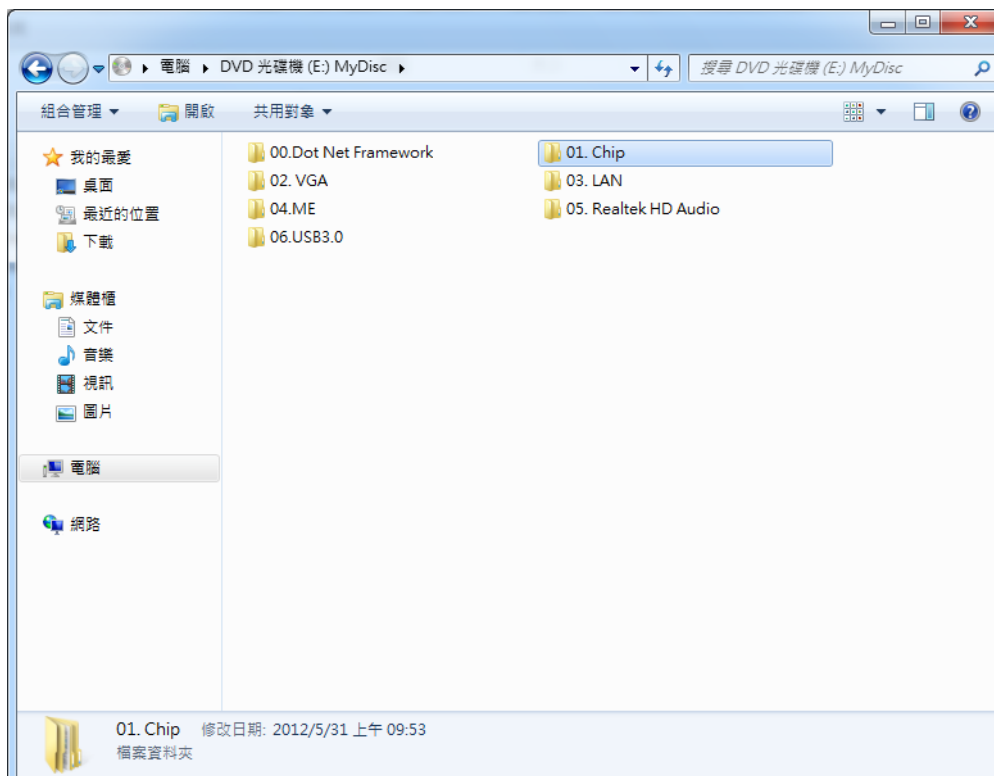

Chapter 6

VGA Setup

6.1 Introduction

The Intel mobile Core i7-2600, Core i5-2400, Core i3-2120, Core i7-3770, Core i5-3550S, Core i3-3220, Pentium G850, Celeron G540 CPUs with dual cores are embedded with an integrated graphics controller. You need to install the VGA driver to enable this function.

Optimized integrated graphic solution: With Intel Graphics Flexible, versatile display options and 32-bit 3D graphics engine are supported. Dual independent displays and enhanced display modes for widescreen flat panels include extended, twin, and clone dual display modes, plus optimized 3D support delivers an intensive and realistic visual experience.

6.2 Windows 7/XP

Note! Before installing this driver, make sure the CSI utility has been installed in your system. See Chapter 5 for information on installing the CSI utility.



Insert the driver CD into your system's CD-ROM drive. Navigate to the "VGA" folder and click "setup.exe" to complete the installation of the drivers for Windows 7 and Windows XP.

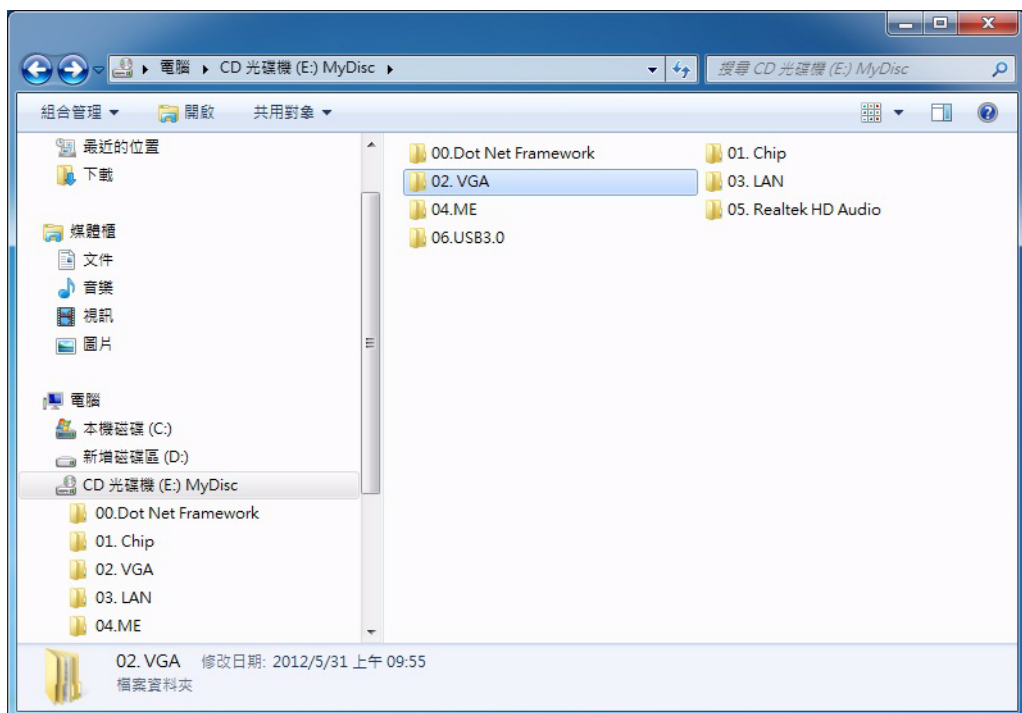

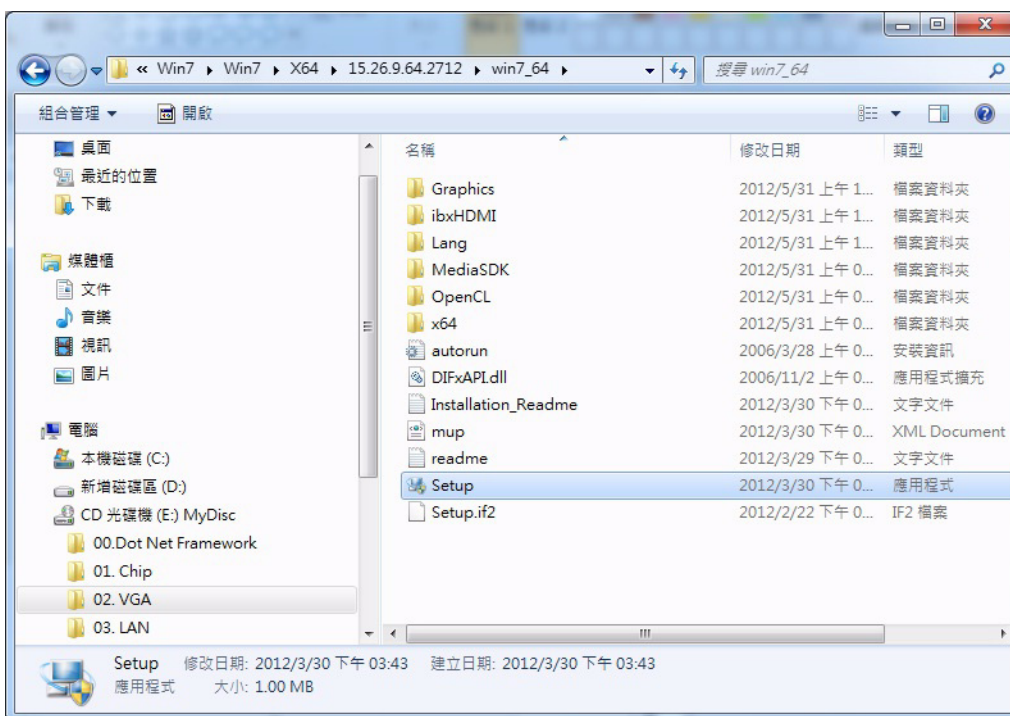
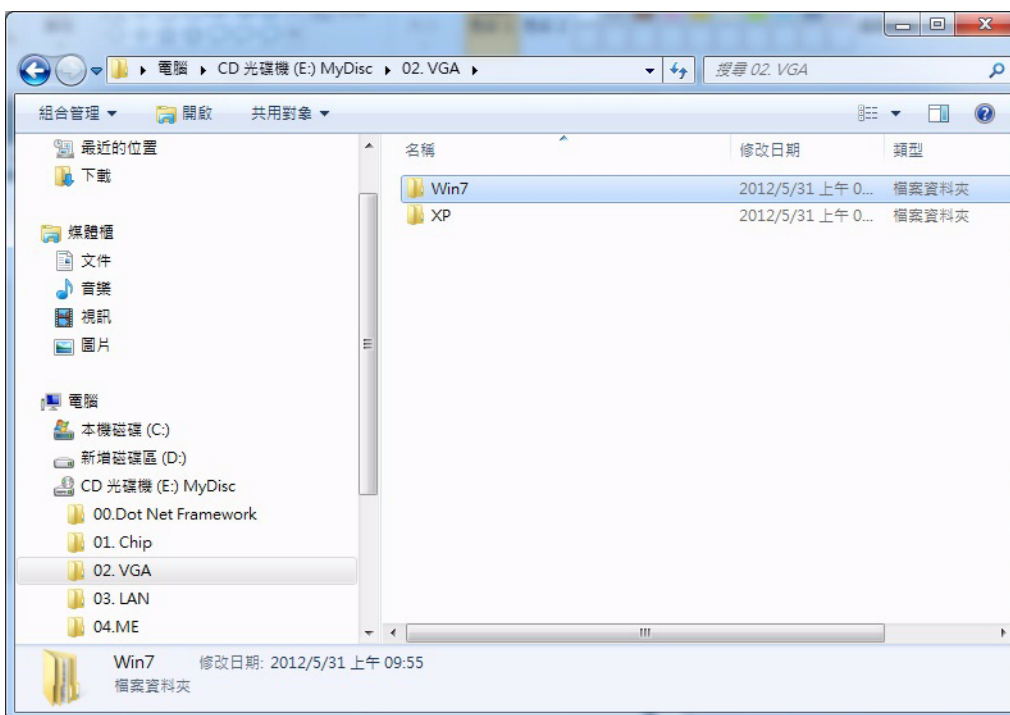

Chapter 7

LAN Configuration

7.1 Introduction

The AIMB-582 has dual Gigabit Ethernet LANs via dedicated PCI Express x1 lanes (Intel 82579LM (LAN1) and 82583V (LAN2)) that offer bandwidth of up to 500 MB/sec, eliminating the bottleneck of network data flow and incorporating Gigabit Ethernet at 1000 Mbps.

7.2 Features

- Integrated 10/100/1000 Mbps transceiver
- 10/100/1000 Mbps triple-speed MAC
- High-speed RISC core with 24-KB cache
- On-chip voltage regulation
- Wake-on-LAN (WOL) support
- PCI Express X1 host interface

7.3 Installation

Note! *Before installing the LAN drivers, make sure the CSI utility has been installed on your system. See Chapter 5 for information on installing the CSI utility.*



The AIMB-582's Intel 82579LM (LAN1) and 82583V (LAN2) Gigabit integrated controllers support all major network operating systems. However, the installation procedure varies from system to system. Please find and use the section that provides the driver setup procedure for the operating system you are using.

7.4 Windows® 7/XP Driver Setup (Intel 82579LM/82583V)

Insert the driver CD into your system's CD-ROM drive. Select the LAN folder then navigate to the directory for your OS.

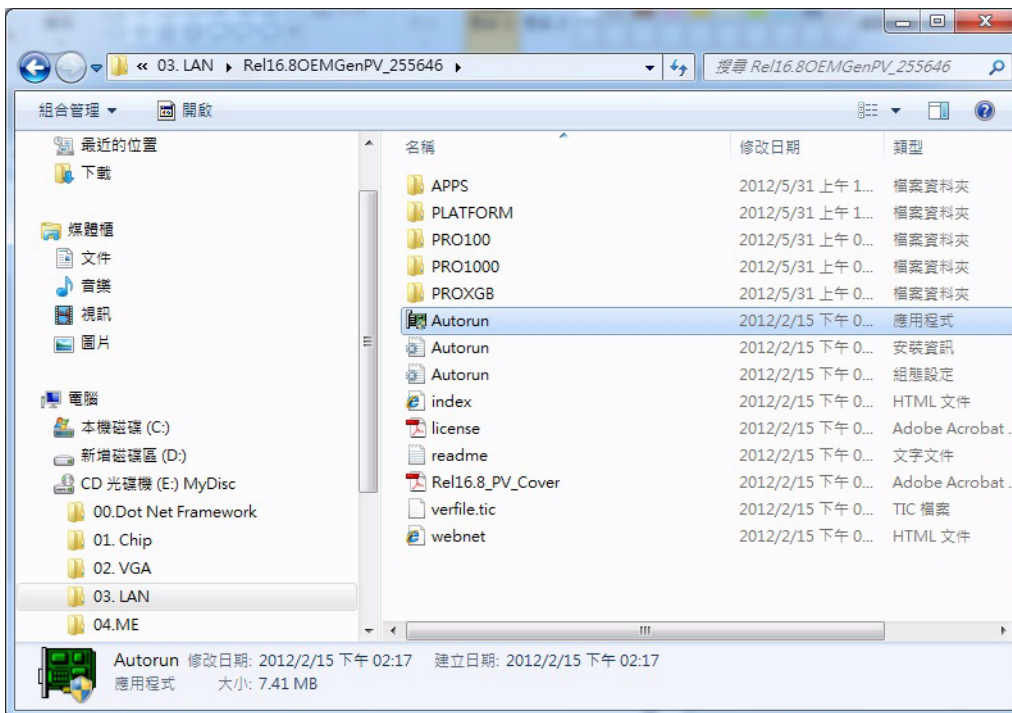
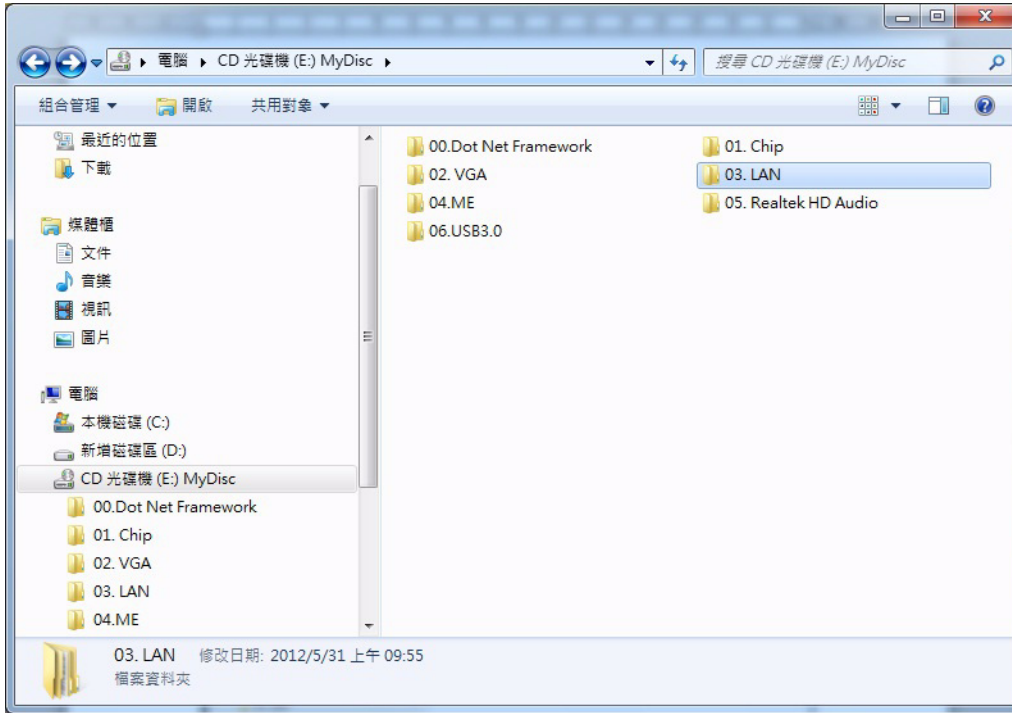

Appendix **A**

Programming the
Watchdog Timer

A.1 Programming the Watchdog Timer

AIMB-582's watchdog timer can be used to monitor system software operation and take corrective action if the software fails to function within the programmed period. This section describes the operation of the watchdog timer and how to program it.

A.1.1 Watchdog Timer Overview

The watchdog timer is built into the super I/O controller Nuvoton NCT6776F. It provides the following user-programmable functions:

- Can be enabled and disabled by user program
- Timer can be set from 1 to 255 seconds or 1 to 255 minutes
- Generates an interrupt or resets signal if the software fails to reset the timer before time-out

A.1.2 Programming the Watchdog Timer

The I/O port address of the watchdog timer is 2E (hex) and 2F (hex). 2E (hex) is the address port. 2F (hex) is the data port. You must first assign the address of register by writing an address value into address port 2E (hex), then write/read data to/from the assigned register through data port 2F (hex).

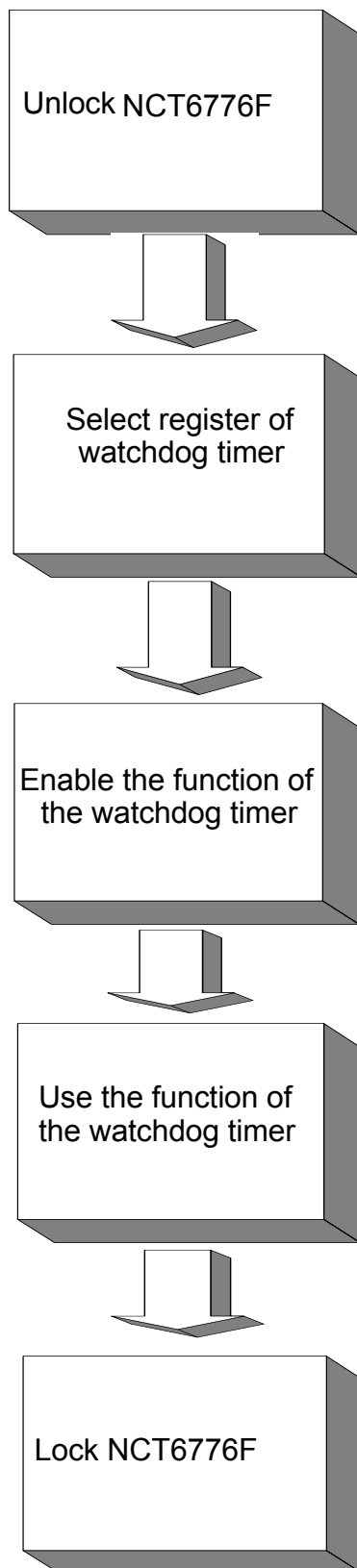

Table A.1: Watchdog Timer Registers

Address of Register (2E)	Attribute	Value (2F) & description
87 (hex)	-----	Write this address to I/O address port 2E (hex) twice to unlock the NCT6776F.
07 (hex)	write	Write 08 (hex) to select register of watchdog timer.
30 (hex)	write	Write 01 (hex) to enable the function of the watchdog timer. Disabled is set as default.
F5 (hex)	write	Set seconds or minutes as units for the timer. Write 0 to bit 3: set second as counting unit. [default] Write 1 to bit 3: set minutes as counting unit.
F6 (hex)	write	0: stop timer [default] 01~FF (hex): The amount of the count, in seconds or minutes, depends on the value set in register F5 (hex). This number decides how long the watchdog timer waits for strobe before generating an interrupt or reset signal. Writing a new value to this register can reset the timer to count with the new value.
F7 (hex)	read/write	Bit 7: Write 1 to enable mouse to reset the timer, 0 to disable [default]. Bit 6: Write 1 to enable keyboard to reset the timer, 0 to disable. [default] Bit 5: Write 1 to generate a timeout signal immediately and automatically return to 0. [default=0] Bit 4: Read status of watchdog timer, 1 means timer is "timeout".
AA (hex)	-----	Write this address to I/O port 2E (hex) to lock the watchdog timer 2.

A.1.3 Example Program

1. Enable watchdog timer and set 10 sec. as timeout interval

```

;-----
Mov dx,2eh ; Unlock NCT6776F
Mov al,87h
Out dx,al
Out dx,al
;-----
Mov al,07h ; Select registers of watchdog timer
Out dx,al
Inc dx
Mov al,08h
Out dx,al
;-----
Dec dx ; Enable the function of watchdog timer
Mov al,30h
Out dx,al
Inc dx
Mov al,01h
Out dx,al
;-----
Dec dx ; Set second as counting unit
Mov al,0f5h
Out dx,al
Inc dx
In al,dx
And al,not 08h
Out dx,al
;-----
Dec dx ; Set timeout interval as 10 seconds and start counting
Mov al,0f6h
Out dx,al
Inc dx
Mov al,10
Out dx,al
;-----
Dec dx ; Lock NCT6776F
Mov al,0aah
Out dx,al

```

2. Enable watchdog timer and set 5 minutes as timeout interval

```

;-----
Mov dx,2eh ; Unlock NCT6776F
Mov al,87h
Out dx,al
Out dx,al

```

```

;-----
Mov al,07h ; Select registers of watchdog timer
Out dx,al
Inc dx
Mov al,08h
Out dx,al
;-----
Dec dx ; Enable the function of watchdog timer
Mov al,30h
Out dx,al
Inc dx
Mov al,01h
Out dx,al
;-----
Dec dx ; Set minute as counting unit
Mov al,0f5h
Out dx,al
Inc dx
In al,dx
Or al,08h
Out dx,al
;-----
Dec dx ; Set timeout interval as 5 minutes and start counting
Mov al,0f6h
Out dx,al
Inc dx
Mov al,5
Out dx,al
;-----
Dec dx ; Lock NCT6776F
Mov al,0aah
Out dx,al
3. Enable watchdog timer to be reset by mouse
;-----
Mov dx,2eh ; Unlock NCT6776F
Mov al,87h
Out dx,al
Out dx,al
;-----
Mov al,07h ; Select registers of watchdog timer
Out dx,al
Inc dx
Mov al,08h
Out dx,al
;-----

```

```

Dec dx ; Enable the function of watchdog timer
Mov al,30h
Out dx,al
Inc dx
Mov al,01h
Out dx,al
;-----
Dec dx ; Enable watchdog timer to be reset by mouse
Mov al,0f7h
Out dx,al
Inc dx
In al,dx
Or al,80h
Out dx,al
;-----
Dec dx ; Lock NCT6776F
Mov al,0aah
Out dx,al
4. Enable watchdog timer to be reset by keyboard
;-----
Mov dx,2eh ; Unlock NCT6776F
Mov al,87h
Out dx,al
Out dx,al
;-----
Mov al,07h ; Select registers of watchdog timer
Out dx,al
Inc dx
Mov al,08h
Out dx,al
;-----
Dec dx ; Enable the function of watchdog timer
Mov al,30h
Out dx,al
Inc dx
Mov al,01h
Out dx,al
;-----
Dec dx ; Enable watchdog timer to be strobed reset by keyboard
Mov al,0f7h
Out dx,al
Inc dx
In al,dx
Or al,40h
Out dx,al

```

```

;-----
Dec dx ; Lock NCT6776F
Mov al,0aah
Out dx,al
5. Generate a time-out signal without timer counting
;-----
Mov dx,2eh ; Unlock NCT6776F
Mov al,87h
Out dx,al
Out dx,al
;-----
Mov al,07h ; Select registers of watchdog timer
Out dx,al
Inc dx
Mov al,08h
Out dx,al
;-----
Dec dx ; Enable the function of watchdog timer
Mov al,30h
Out dx,al
Inc dx
Mov al,01h
Out dx,al
;-----
Dec dx ; Generate a time-out signal
Mov al,0f7h
Out dx,al ;Write 1 to bit 5 of F7 register
Inc dx
In al,dx
Or al,20h
Out dx,al
;-----
Dec dx ; Lock NCT6776F
Mov al,0aah
Out dx,al

```

Appendix **B**

Pin Assignments

B.1 USB Header (USB45,USB89,USB1011,USB1213)

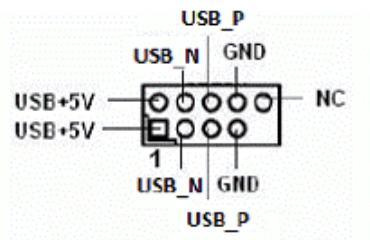

Table B.1: USB Header (USB56)

Pin	Signal	Pin	Signal
1	+V5_USB	2	+V5_USB
3	USB4N	4	USB5N
5	USB4P	6	USB5P
7	GND	8	GND
		10	NC

B.2 VGA Connector (VGA1)

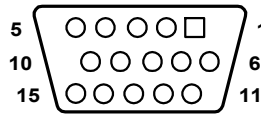

Table B.2: VGA Connector (VGA1)

Pin	Signal	Pin	Signal
1	RED	9	CRT_VCCIN
2	VGA_G	10	GND
3	VGA_B	11	N/C
4	N/C	12	V_SDAT
5	GND	13	H-SYNC
6	GND	14	V-SYNC
7	GND	15	V_SCLK

B.3 eDP1: eDP Connector

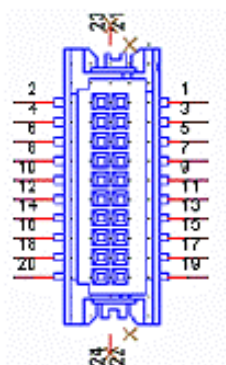

Table B.3: eDP1: eDP Connector

Pin	Pin Name	Pin	Pin Name
1	GND	2	GND
3	EDP0-	4	EDP3-
5	EDP0+	6	EDP3+
7	GND	8	NC
9	EDP1-	10	GND
11	EDP1+	12	EAUX-
13	GND	14	EAUX+
15	EDP2-	16	GND
17	EDP2+	18	DDPD_DP_HPDP
19	VDD_1	20	VDD_LVDS1

B.4 SPI_CN1: SPI Fresh Card Pin Connector

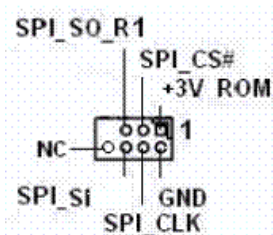

Table B.4: SPI_CN1: SPI Fresh Card Pin Connector

Pin	Pin Name	Pin	Pin Name
1	+3.3 V_SPI	2	GND
3	SPI_CS#	4	SPI_CLK
5	SPI_SO_R1	6	SPI_SI
		8	NC

B.5 PS/2 Keyboard and Mouse Connector (KBMS1)

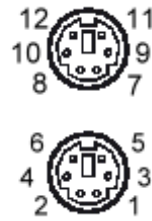

Table B.5: PS/2 Keyboard and Mouse Connector (KBMS1)

Pin	Signal
1	KB DATA
2	N/C
3	GND
4	KB VCC
5	KB CLK
6	N/C
7	M_DATA
8	N/C
9	GND
10	M_VCC
11	M_CLK
12	N/C

B.6 RS-232 Interface (COM3/4/5/6)

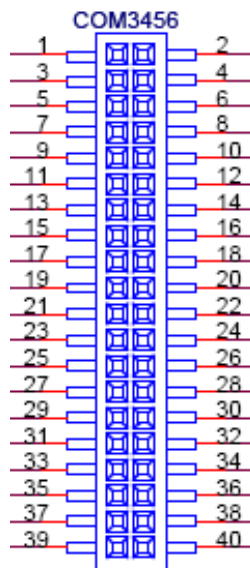
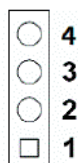

Table B.6: RS-232 Interface (COM3/4/5/6)

Pin	Pin Name	Pin	Pin Name
1	COM3_DCD#	2	COM3_DSR#
3	COM3_SIN	4	COM3_RTS#
5	COM3_SOUT	6	COM3_CTS#
7	COM3_DTR#	8	COM3_RI#
9	GND	10	GND
11	COM4_DCD#	12	COM4_DSR#
13	COM4_SIN	14	COM4_RTS#
15	COM4_SOUT	16	COM4_CTS#
17	COM4_DTR#	18	COM4_RI#
19	GND	20	GND
21	COM5_DCD#	22	COM5_DSR#
23	COM5_SIN	24	COM5_RTS#
25	COM5_SOUT	26	COM5_CTS#
27	COM5_DTR#	28	COM5_RI#
29	GND	30	GND
31	COM6_DCD#	32	COM6_DSR#
33	COM6_SIN	34	COM6_RTS#
35	COM6_SOUT	36	COM6_CTS#
37	COM6_DTR#	38	COM6_RI#
39	GND	40	GND

B.7 CPU Fan Power Connector (CPU_FAN1)

**Table B.7: CPU Fan Power Connector (CPU_FAN1)**

Pin	Pin Name
1	GND
2	CPU_FAN_PWN
3	CPU_FAN_SPEED
4	NC

B.8 System Fan Power Connector (SYS_FAN1/2/3/4)

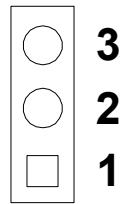

Table B.8: System Fan Power Connector (SYSFAN1/SYSFAN2/SYSFAN3/SYSFAN4)

Pin	Signal
1	GND
2	+12 V PWM
3	DETECT

B.9 Power LED & Keyboard Lock Connector (JFP3)

You can use an LED to indicate when the single board computer is on. Pin 1 of JFP3 supplies the LED's power, and Pin 3 is the ground.

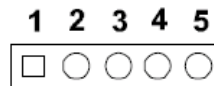

Table B.9: Power LED & Keyboard Lock Connector (JFP3)

Pin	Pin Name
1	+3 V
2	N/A
3	SUSLED
4	KEYLOCK#
5	GND

B.10 Power Switch/HDD LED/SMBus/Speaker (JFP1/2)

The single board computer has its own buzzer. You can also connect it to the external speaker on your computer chassis.

3	6	9	12
2	5	8	11
1	4	7	10

Table B.10: Power switch/HDD LED/SMBus/Speaker (JFP1/2)

Pin	Pin Name	Pin	Pin Name
1	SPK_CN17P1	2	+ V3.3
3	PANSWIN#	4	SPK_CN17P2
5	SATALED#	6	GND
7	SPK_CN17P3	8	SNMP_SDA
9	SYS_RST#	10	SPK_CN17P4
11	SNMP_SCL	12	GND

B.11 USB/LAN ports (LAN1_USB12/LAN2_USB34)

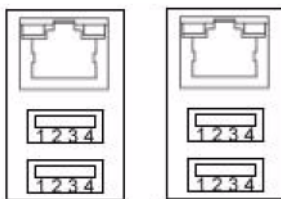

Table B.11: USB Port

Pin	Signal	Pin	Signal
1	VCC	3	Data0+
2	Data0-	4	GND

Table B.12: Ethernet 10/100 Mbps RJ-45 Port

Pin	Signal	Pin	Signal
1	XMT+	5	N/C
2	XMT-	6	RCV-
3	RCV+	7	N/C
4	N/C	8	N/C

B.12 Line Out, Mic In Connector (AUDIO1)

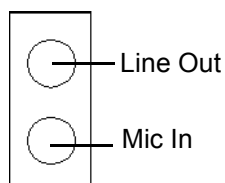

B.13 Serial ATA0/1 (SATA1 ~ 6)

Table B.13: Serial ATA 0/1 (SATA1 ~ 6)

Pin	Signal	Pin	Signal
1	GND	2	SATA_0TX+
3	SATA_0TX-	4	GND
5	SATA_0RX-	6	SATA_0RX+
7	GND	8	

B.14 AT/ATX Mode (PSON1)

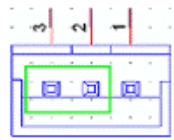

Table B.14: AT/ATX Mode (PSON1)

Pin	Pin Name
1	AT
2	+V3.3
3	ATX

B.15 HD Audio Interface (FPAUD1)

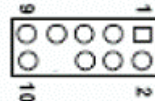

Table B.15: HD Audio Interface (FPAUD1)

Description		Audio front panel connector	
Pin	Pin Name	Pin	Pin Name
1	MIC2_L	2	GND
3	MIC2_R	4	PRESENCE#
5	LINE2-R	6	MIC2-JD
7	FRONT-IO-SENSE_R	8	GND
9	LINE2-L	10	LINE2-JD

B.16 GPIO Pin Header (GPIO1)

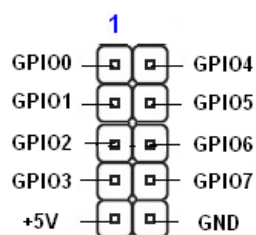

Table B.16: GPIO Pin Header (GPIO1)

Pin	Signal	Pin	Signal
1	GPIO0	2	GPIO4
3	GPIO1	4	GPIO5
5	GPIO2	6	GPIO6
7	GPIO3	8	GPIO7
9	+5V	10	GND

B.17 LVDS Connector: LVDS1

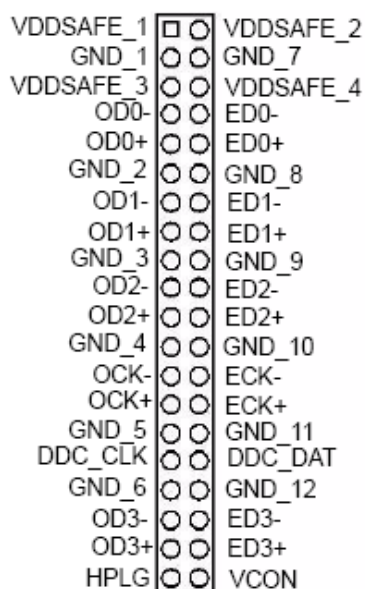

Table B.17: LVDS Connector: LVDS1

Pin	Pin Name	Pin	Pin Name	Pin	Pin Name
1	VDD_LVDS1	15	LA_DATAP1	29	GND
2	VDD_LVDS1	16	LB_DATAP1	30	GND
3	GND	17	GND	31	L_DDC_CLKR
4	GND	18	GND	32	L_DDC_DATR
5	VDD_LVDS1	19	LA_DATAN2	33	GND
6	VDD_LVDS1	20	LB_DATAN2	34	GND
7	LA_DATAN0	21	LA_DATAP2	35	LA_DATAN3
8	LB_DATAN0	22	LB_DATAP2	36	LB_DATAN3

Table B.17: LVDS Connector: LVDS1

9	LA_DATAP0	23	GND	37	LA_DATAP3
10	LB_DATAP0	24	GND	38	LB_DATAP3
11	GND	25	LA_CLKN	39	L_BKLTEN
12	GND	26	LB_CLKN	40	VCON (VESA / JEIDA select)
13	LA_DATAN1	27	LA_CLKP		
14	LB_DATAN1	28	LB_CLKP		

B.18 LVDS Power Jumper (JLVDS1/2)

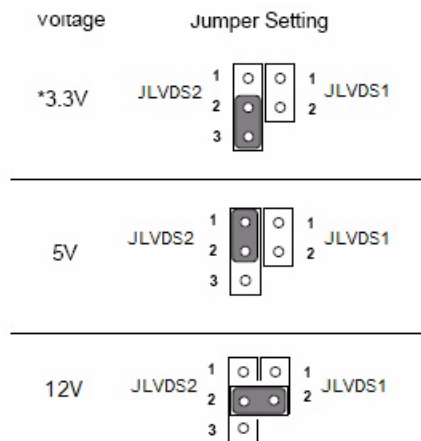

* default setting

Table B.18: LVDS Power Jumper

LVDS1		LVDS2	
Pin	Signal	Pin	Signal
1	NC	1	+V3.3
2	+V12	2	+V_LCD_S (LCD power)
		3	+V5

B.19 LVDS Inverter (INV1)

Table B.19: LVDS Inverter (INV1)

Pin	Pin Name
1	+V12_INV1
2	GND
3	LVDS1_ENBKL
4	LVDS1_VBR
5	+V5_INV1

B.20 ATX Power Connector (ATXPWR1, EATPWR1)

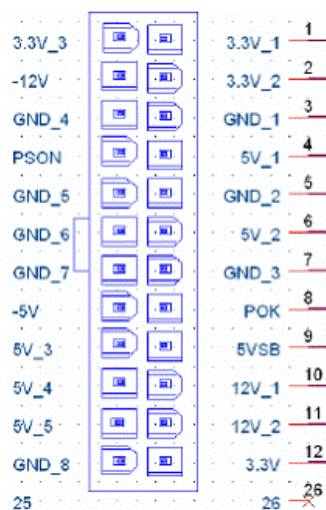

Table B.20: ATX Power Connector (ATXPWR1, EATPWR1)

Pin	Pin Name	Pin	Pin Name
1	+3.3V	13	+3.3V
2	+3.3V	14	-12V
3	GND	15	GND
4	+5V	16	PS_ON#
5	GND	17	GND
6	+5V	18	GND
7	GND	19	GND
8	ATXPG	20	-5V
9	5VSB	21	+5V
10	+12V	22	+5V
11	+12V	23	+5V
12	+3.3V	24	GND

B.21 ATX 12 V Connector (ATX12V1)

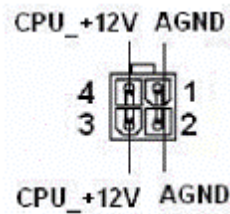

Table B.21: ATX 12 V Connector (ATX12V1)

Pin	Pin Name
1	GND
2	GND
3	+V12_4P
4	+V12_4P

B.22 JTAG (Joint Test Action Group Connector)

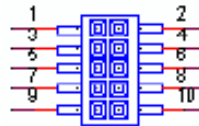

Table B.22: Joint Test Action Group (JTAG)

Pin	Pin Name
1	TCK
2	BSCAN_ON#
3	TMS
4	GND
5	TDI
6	GND
7	TDO
8	GND
9	TRST#
10	NC

B.23 JUSBPWR1-4 (USB Power Selection Connector)

Table B.23: JUSBPWR1-4 (USB Power Selection Connector)

Pin	Pin Name
1	+V5_DUAL
2	+V5_USB
3	+V5

B.24 DMA Channel Assignments

Table B.24: DMA Channel Assignments

Channel	Function
0	Available
1	Available
2	N/A
3	Available
4	Cascade for DMA controller 1
5	Available
6	Available
7	Available

B.25 Interrupt Assignments

Table B.25: Interrupt Assignments

Priority	Interrupt#	Interrupt source
1	NMI	Parity error detected
2	IRQ0	Interval timer
3	IRQ1	Keyboard
-	IRQ2	Interrupt from controller 2 (cascade)
4	IRQ8	Real-time clock
5	IRQ9	Cascaded to INT 0A (IRQ 2)
6	IRQ10	Serial communication port 4/6
7	IRQ11	Serial communication port 3/5
8	IRQ12	PS/2 mouse
9	IRQ13	INT from co-processor
10	IRQ14	Primary IDE Channel
11	IRQ15	Secondary IDE Channel
12	IRQ3	Serial communication port 2
13	IRQ4	Serial communication port 1
14	IRQ5	Available
15	IRQ6	Available
16	IRQ7	Parallel port 1 (print port)

B.26 1st MB Memory Map

Table B.26: 1st MB Memory Map

Addr. range (Hex)	Device
E0000h - FFFFFh	BIOS
CC000h - DFFFFh	Unused
C0000h - CBFFFh	VGA BIOS
A0000h - BFFFFh	Video Memory
00000h - 9FFFFh	Base memory

ADVANTECH

Enabling an Intelligent Planet

www.advantech.com

Please verify specifications before quoting. This guide is intended for reference purposes only.

All product specifications are subject to change without notice.

No part of this publication may be reproduced in any form or by any means, electronic, photocopying, recording or otherwise, without prior written permission of the publisher.

All brand and product names are trademarks or registered trademarks of their respective companies.

© Advantech Co., Ltd. 2012