



500 Watt Low Capacitance Transient Voltage Suppressors

Screening in
reference to
MIL-PRF-19500
available

DESCRIPTION

This series of MSMBSAC5.0 – MSMBSAC75 high reliability Transient Voltage Suppressors are featured in the SMBJ J-bend design (DO-214AA package) which allows for greater PC board mounting density. They feature unidirectional construction and working standoff voltage (V_{WM}) selections from 5 to 75 volts. It is available with either SnPb or RoHS compliant matte-tin plating.

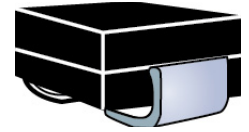

**DO-214AA
J-bend Package**

Important: For the latest information, visit our website <http://www.microsemi.com>.

NOTE: All SMB series are equivalent to prior SMS package identifications.

FEATURES

- Unidirectional low-capacitance device (30 pF). For bidirectional applications, see [Figure 6](#).
- 3σ lot norm screening performed on standby current I_D
- 100% surge testing of all devices
- Suppresses transients up to 500 W Peak Pulse Power (P_{PP}) @ 10/1000 μ s
- Working standoff voltage (V_{WM}) values from 5 to 75 V
- Various screenings in reference to MIL-PRF-19500 are available. Refer to [Hirel Non-Hermetic Product Portfolio](#) for more details on the screening options.
(See [part nomenclature](#) for all options.)
- High reliability controlled devices have wafer fabrication and assembly lot traceability
- Moisture classification is Level 1 with no dry pack required per IPC/JEDEC J-STD-020B
- RoHS compliant versions available

APPLICATIONS / BENEFITS

- Low capacitance for data-line protection to 10 MHz
- Protection for fast data rate lines in aircraft up to:
 - RTCA/DO-160G - Waveform 4 and Waveform 5A (also see [MicroNote 130](#))
 - ARINC 429, Part 1, paragraph 2.4.1.1 up to bit rates of 100 kb/s
- ESD and EFT protection per IEC61000-4-2 and IEC61000-4-4 respectively
- Secondary lightning protection per IEC 61000-4-5 with 42 ohms source impedance:
 - Class 1: MSMBSAC5.0 to MSMBSAC75
 - Class 2: MSMBSAC5.0 to MSMBSAC45
 - Class 3: MSMBSAC5.0 to MSMBSAC22
 - Class 4: MSMBSAC5.0 to MSMBSAC10
- Secondary lightning protection per IEC 61000-4-5 with 12 ohms source impedance:
 - Class 1: MSMBSAC5.0 to MSMBSAC26
 - Class 2: MSMBSAC5.0 to MSMBSAC15
 - Class 3: MSMBSAC5.0 to MSMBSAC7.0

MSC – Lawrence

6 Lake Street,
Lawrence, MA 01841
Tel: 1-800-446-1158 or
(978) 620-2600
Fax: (978) 689-0803

MSC – Ireland

Gort Road Business Park,
Ennis, Co. Clare, Ireland
Tel: +353 (0) 65 6840044
Fax: +353 (0) 65 6822298

Website:

www.microsemi.com

MAXIMUM RATINGS @ 25 °C unless otherwise stated

Parameters/Test Conditions	Symbol	Value	Unit
Junction and Storage Temperature	T _J and T _{STG}	-65 to +150	°C
Peak Pulse Power Dissipation @ 10/1000 μs ⁽¹⁾	P _{PP}	500	W
Average Power Dissipation @ T _L = +75 °C ⁽²⁾	P _{M(AV)}	2.5	W
Clamping Speed (0 volts to V _(BR) min, theoretical)	t _{clamping}	< 5	ns
Solder Temperature @ 10 s		260	°C

- Notes:**
- With impulse repetition rate (duty factor) of 0.01 % max. TVS devices are not typically used for dc power dissipation and are instead operated $\leq V_{WM}$ (rated standoff voltage) except for transients that briefly drive the device into avalanche breakdown (V_(BR) to V_C region) of the TVS element. Also see [Figures 5 and 6](#) for further protection details in rated peak pulse power for unidirectional and bidirectional configurations respectively.
 - At 3/8 (10 mm) lead length from body.

MECHANICAL and PACKAGING

- CASE: Void-free transfer molded thermosetting epoxy body meeting UL94V-0 requirements
- TERMINALS: Tin-lead or RoHS compliant annealed matte-tin plating readily solderable per MIL-STD-750, method 2026
- MARKING: Part number
- POLARITY: Cathode end banded
- TAPE & REEL option: Standard per EIA-481-1-A (add "TR" suffix to part number). Consult factory for quantities.
- WEIGHT: Approximately 0.1 grams
- See [Package Dimensions](#) on last page.

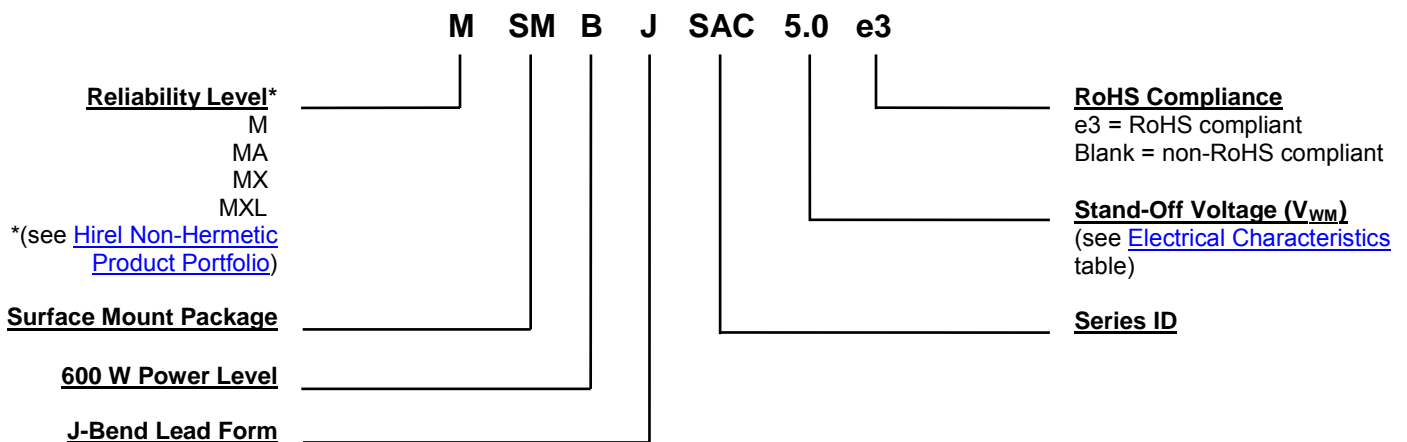
PART NOMENCLATURE

SYMBOLS & DEFINITIONS

Symbol	Definition
C_T	Total Capacitance: The total small signal capacitance between the diode terminals of a complete device.
$I_{(BR)}$	Breakdown Current: The current used for measuring Breakdown Voltage $V_{(BR)}$.
I_D	Standby Current: The current through the device at rated stand-off voltage.
I_{PP}	Peak Impulse Current: The maximum rated random recurring peak impulse current or nonrepetitive peak impulse current that may be applied to a device. A random recurring or nonrepetitive transient current is usually due to an external cause, and it is assumed that its effect will have completely disappeared before the next transient arrives.
P_{PP}	Peak Pulse Power: The rated random recurring peak impulse power or rated nonrepetitive peak impulse power. The impulse power is the maximum-rated value of the product of I_{PP} and V_C .
$V_{(BR)}$	Breakdown Voltage: The voltage across the device at a specified current $I_{(BR)}$ in the breakdown region.
V_C	Clamping Voltage: The voltage across the device in a region of low differential resistance during the application of an impulse current (I_{PP}) for a specified waveform.
V_{WM}	Working Standoff Voltage: The maximum-rated value of dc or repetitive peak positive cathode-to-anode voltage that may be continuously applied over the standard operating temperature.

ELECTRICAL CHARACTERISTICS @ 25 °C unless otherwise stated

PART NUMBER	WORKING STAND-OFF VOLTAGE (Note 1) V_{WM}	BREAKDOWN VOLTAGE V_{BR} @ I_{BR} 1.0mA $V_{(BR)}$	MAXIMUM STANDBY CURRENT I_D @ V_{WM}	MAXIMUM CLAMPING VOLTAGE V_C @ $I_P = 5.0A$	MAXIMUM PEAK PULSE CURRENT* RATING (Note 2) I_{PP}	MAXIMUM CAPACITANCE @ 0 Volts $f = 1$ MHz C_T	WORKING INVERSE BLOCKING VOLTAGE V_{WIB}	INVERSE BLOCKING LEAKAGE CURRENT @ V_{WIB} I_{IB}	PEAK INVERSE BLOCKING VOLTAGE V_{PIB}
	Volts	Volts (min)	μA	Volts	Amps	pF	Volts	μA	Volts
MSMBSAC5.0	5.0	7.60	300	10.0	44	30	75	10	100
MSMBSAC6.0	6.0	7.90	300	11.2	41	30	75	10	100
MSMBSAC7.0	7.0	8.33	300	12.6	38	30	75	10	100
MSMBSAC8.0	8.0	8.89	100	13.4	36	30	75	10	100
MSMBSAC8.5	8.5	9.44	50	14.0	34	30	75	10	100
MSMBSAC10	10	11.10	5.0	16.3	29	30	75	10	100
MSMBSAC12	12	13.30	5.0	19.0	25	30	75	10	100
MSMBSAC15	15	16.70	5.0	23.6	20	30	75	10	100
MSMBSAC18	18	20.00	5.0	28.8	15	30	75	10	100
MSMBSAC22	22	24.40	5.0	35.4	14	30	75	10	100
MSMBSAC26	26	28.90	5.0	42.3	11.1	30	75	10	100
MSMBSAC36	36	40.0	5.0	60.0	8.6	30	75	10	100
MSMBSAC45	45	50.00	5.0	77.0	6.8	30	150	10	200
MSMBSAC50	50	55.50	5.0	88.0	5.8	30	150	10	200
MSMBSAC75	75	83.3	5.0	121	4.1	30	150	10	200

*See [Figure 3](#). For the MSMBSAC75, the maximum clamping voltage V_C is at the maximum rated Peak Pulse Current (I_{PP}) of 4.1 Amps.

Clamping Factor: The ratio of the numerical value of V_C to $V_{(BR)}$ is typically 1.4 @ full rated power, 1.20 @ 50% rated power. Also see [MicroNote 108](#).

Note 1: A Transient Voltage Suppressor is normally selected according to voltage (V_{WM}), which should be equal to or greater than the dc or continuous peak operating voltage level.

Note 2: Test in TVS avalanche direction. Do not pulse in "forward" direction. See section for [Application Schematics](#) herein.

GRAPHS

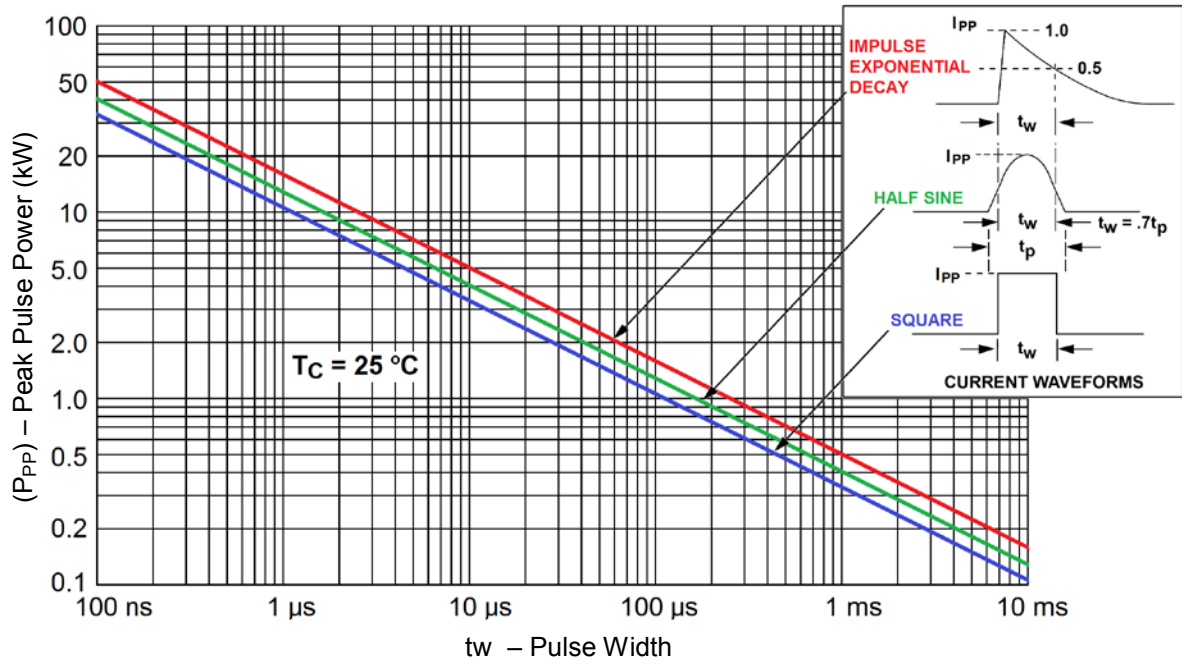

FIGURE 1
Peak Pulse Power vs Pulse Time

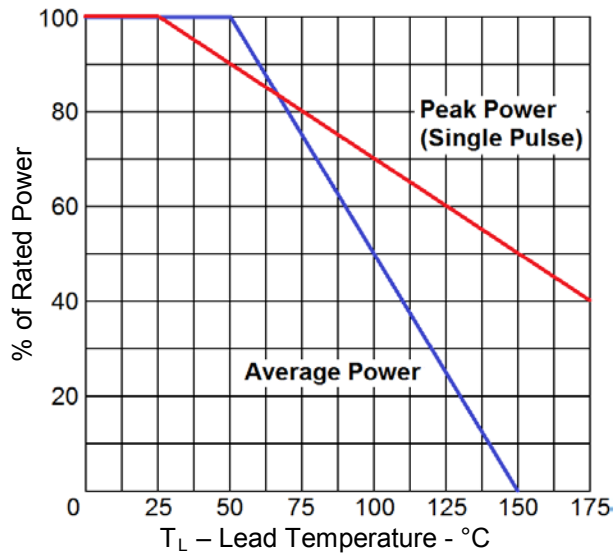

Figure 2
Rated Power vs Lead Temperature
(At Lead Length = 3/8")

GRAPHS (continued)

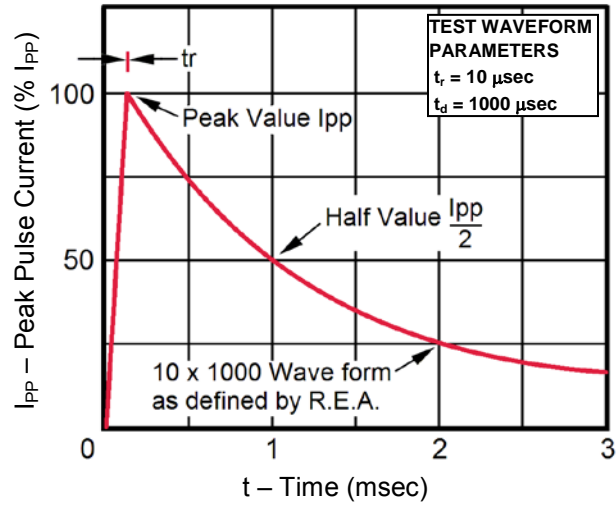
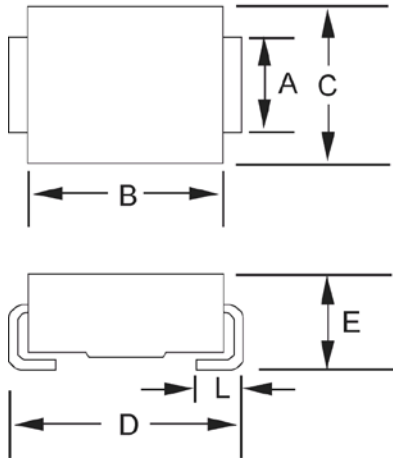
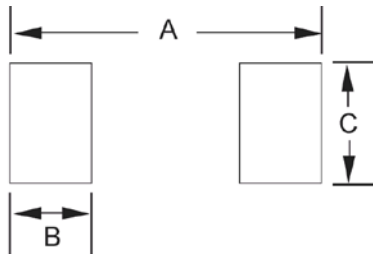

Figure 3
Peak Pulse Current vs Time

PACKAGE DIMENSIONS

SMBJ (DO-214AA)

Ltr	Dimensions			
	Inch		Millimeters	
	Min	Max	Min	Max
A	0.077	0.083	1.96	2.10
B	0.160	0.180	4.06	4.57
C	0.130	0.155	3.30	3.94
D	0.205	0.220	5.21	5.59
E	0.077	0.104	1.95	2.65
L	0.030	0.060	0.76	1.52

PAD LAYOUT

SMBJ (DO-214AA)		
Ltr	Inch	Millimeters
A	0.260	6.60
B	0.085	2.16
C	0.110	2.79

See applications schematics on next page.

APPLICATION SCHEMATICS

The TVS low capacitance device configuration is shown in Figure 4. As a further option for unidirectional applications, an additional low capacitance rectifier diode may be used in parallel in the same polarity direction as the TVS as shown in Figure 5. In applications where random high voltage transients occur, this will prevent reverse transients from damaging the internal low capacitance rectifier diode and also provide a low voltage conducting direction. The added rectifier diode should be of similar low capacitance and also have a higher reverse voltage rating than the TVS clamping voltage V_C . The Microsemi recommended rectifier part number is the "[SMBJLCR60](#)" for the application in Figure 5. If using two (2) low capacitance TVS devices in anti-parallel for bidirectional applications, this added protective feature for both directions (including the reverse of each rectifier diode) is also provided. The unidirectional and bidirectional configurations in Figure 5 and 6 will both result in twice the capacitance of Figure 4.

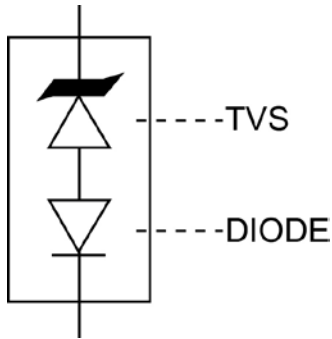

Figure 4
TVS with internal
Low capacitance diode

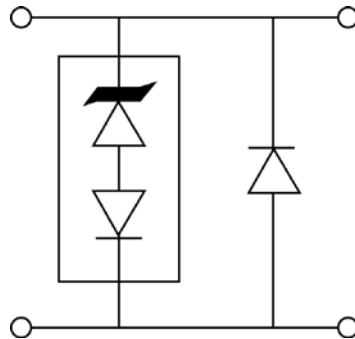

Figure 5
Optional Unidirectional
configuration (TVS and
separate rectifier diode
in parallel)

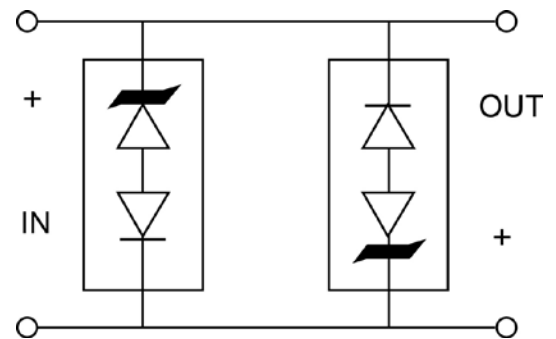

Figure 6
Optional Bidirectional
configuration (two TVS
devices in anti-parallel)